

The image features a large green diagonal shape on the left side. The background is a photograph of a man in a straw hat and a plaid shirt, smiling and holding a small plant. Behind him is a vast field of rows of young plants, likely a vineyard or orchard, under a bright sky. The overall theme is agriculture and farming.

Black
R O D O A G R O

CATÁLOGO 2022

ÍNDICE

- 3. AGRALE
- 4. CARRARO
- 6. CASE
- 45. CATERPILLAR
- 68. CBT
- 69. CLARK
- 70. DOOSAN
- 71. FIAT
- 82. FORD / NEW HOLLAND
- 90. HUBER WARCO
- 91. HYSTER
- 93. HYUNDAI
- 97. JACTO
- 98. JOHN DEERE
- 101. KOMATSU
- 119. LANDINI
- 120. LIUGONG
- 121. LS MTRON
- 122. MAHINDRA
- 123. MASSEY FERGUSON
- 144. MICHIGAN
- 148. MONTANA
- 149. MOTOcana
- 151. PAUNY
- 152. RANDON
- 158. SANTEL
- 160. SANY
- 164. SDLG
- 165. STARA
- 166. TRAMONTINI
- 167. URSUS
- 168. VALMET / VALTRA
- 174. VOLVO
- 175. SCMG
- 177. XGMA
- 178. YALE
- 179. ZF
- 181. OUTROS



16 9 9740-4600



www.blackrodoagro.com.br



16 99772-1884



agro@blackrodoagro.com.br



Cel Jose Augusto de Oliveira Salles, 03 Vila Izabel
CEP: 13570-820 - São Carlos SP



facebook.com/rodoagroblack



instagram.com/blackrodoagro

CONJUNTO CARÇA DE ARTICULAÇÃO PARA MÁQUINAS AGRALE

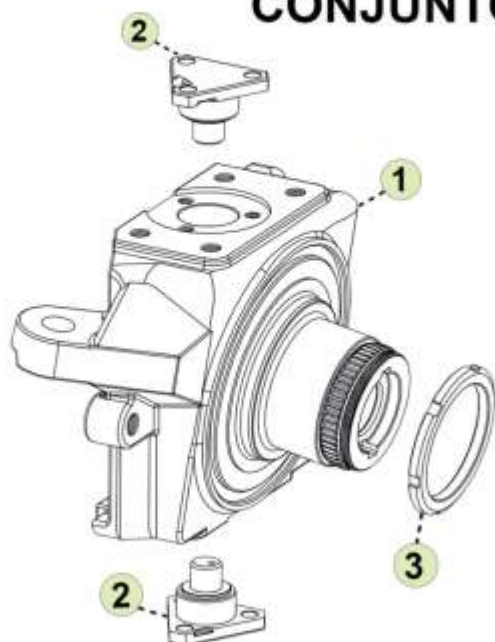

CARÇA
8009103482009 LD
8009103483007 LE





















PIVÔ
8009103262005

PORCA
8009103374008

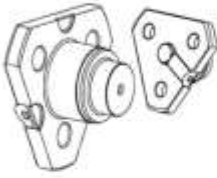
ACOMPANHA

POS.	QTD.	DESCRIÇÃO
1	01	Carça
2	02	Pivô
3	01	Porca

<p>BUCHA</p> <p>8009103132000</p>	<p>BUCHA</p> <p>8013103051004</p>	<p>ARRUELA</p> <p>8020103054003</p>	<p>PORCA</p> <p>8009103374008</p>
<p>PORTADOR PLANETÁRIO</p> <p>8009103399005</p>	<p>PORTADOR PLANETÁRIO</p> <p>8009103303007</p>	<p>PIVÔ (FORJADO)</p> <p>8009103262005</p>	<p>CARÇA DE ARTICULAÇÃO</p> <p>8009103483007 LE</p>
<p>CARÇA DE ARTICULAÇÃO</p> <p>8009103482009 LD</p>	<p>ENGRENAGEM</p> <p>80121030640099</p>		

<p>BUCHA</p>  <p>CAR101565</p>	<p>BUCHA</p>  <p>CAR123475</p>	<p>BUCHA</p>  <p>CAR123495</p>	<p>BUCHA</p>  <p>CAR125495</p>
<p>BUCHA</p>  <p>CAR126631</p>	<p>BUCHA</p>  <p>CAR126632</p>	<p>BUCHA</p>  <p>CAR133148</p>	<p>BUCHA</p>  <p>CAR137943</p>
<p>BUCHA</p>  <p>CAR138560</p>	<p>RÓTULA</p>  <p>CAR123726</p>	<p>RÓTULA</p>  <p>CAR27692</p>	<p>ARRUELA</p>  <p>CAR126629</p>
<p>ARRUELA</p>  <p>CAR126630</p>	<p>PIVÔ (FORJADO)</p>  <p>CAR128881</p>	<p>PIVÔ (FORJADO)</p>  <p>CAR125149</p>	<p>PIVÔ (FORJADO)</p>  <p>CAR128904</p>
<p>CARCAÇA DE ARTICULAÇÃO</p>  <p>6224548M1 LE</p>	<p>CARCAÇA DE ARTICULAÇÃO</p>  <p>6224550M1 LD</p>	<p>PORTADOR PLANETÁRIO</p>  <p>3208588</p>	<p>PORTADOR PLANETÁRIO</p>  <p>CAR128955</p>

ENGRENAGEM









































CAR125455



ENGRENAGEM

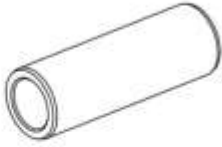

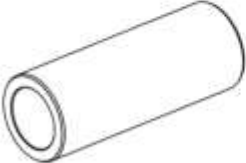





















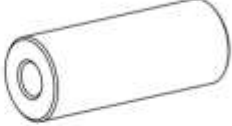
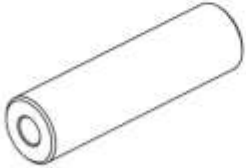
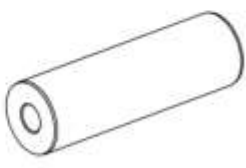



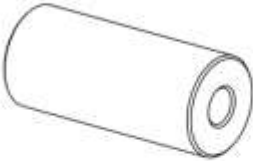

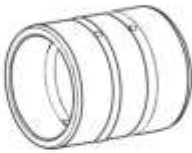
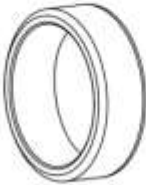





CAR128714











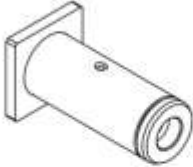
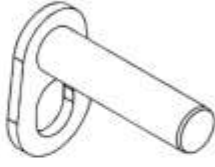





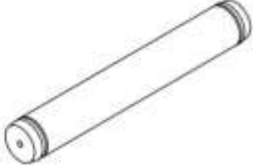

<p>BUCHA</p>  <p>75261188</p>	<p>BUCHA</p>  <p>84217542</p>	<p>BUCHA</p>  <p>84223633</p>	<p>BUCHA</p>  <p>84224880</p>
<p>BUCHA</p>  <p>84226809</p>	<p>BUCHA</p>  <p>84246051</p>	<p>BUCHA</p>  <p>84247140</p>	<p>BUCHA</p>  <p>84529088</p>
<p>BUCHA</p>  <p>87310767</p>	<p>BUCHA</p>  <p>87613430</p>	<p>BUCHA</p>  <p>87613433</p>	<p>BUCHA</p>  <p>87613434</p>
<p>BUCHA</p>  <p>87613438</p>	<p>BUCHA</p>  <p>87613439</p>	<p>BUCHA</p>  <p>87613444</p>	<p>BUCHA</p>  <p>100520A1</p>
<p>BUCHA</p>  <p>100522A1</p>	<p>BUCHA</p>  <p>121778A1</p>	<p>BUCHA</p>  <p>137248A1</p>	<p>BUCHA</p>  <p>141005A1</p>



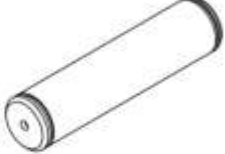

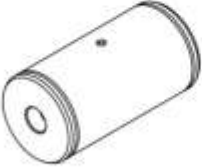

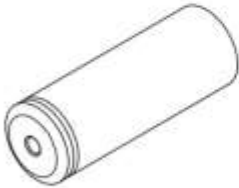



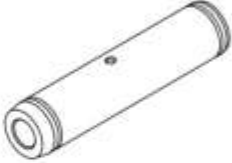
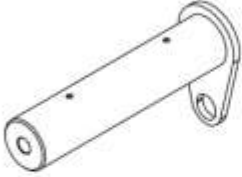

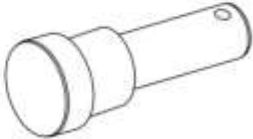
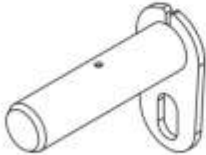
<p>BUCHA</p>  <p>148657A1</p>	<p>BUCHA</p>  <p>148658A1</p>	<p>BUCHA</p>  <p>180427A1</p>	<p>BUCHA</p>  <p>336388A1</p>
<p>BUCHA</p>  <p>339521A1</p>	<p>BUCHA</p>  <p>124568A2</p>	<p>BUCHA</p>  <p>371885A2</p>	<p>BUCHA</p>  <p>379091A2</p>
<p>BUCHA</p>  <p>1980371C1</p>	<p>BUCHA</p>  <p>A17122</p>	<p>BUCHA</p>  <p>A17611</p>	<p>BUCHA</p>  <p>A28230</p>
<p>BUCHA</p>  <p>A38930</p>	<p>BUCHA</p>  <p>A75239</p>	<p>BUCHA</p>  <p>D30931</p>	<p>BUCHA</p>  <p>D31219</p>
<p>BUCHA</p>  <p>D37416</p>	<p>BUCHA</p>  <p>D37450</p>	<p>BUCHA</p>  <p>D45904</p>	<p>BUCHA</p>  <p>D50698</p>

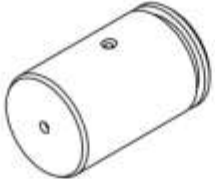
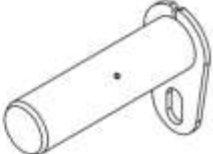



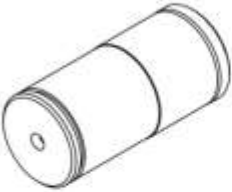
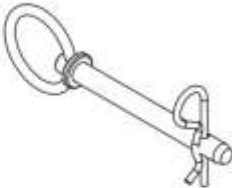





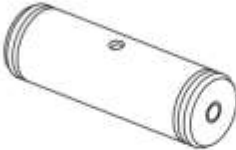
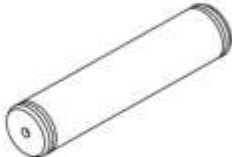
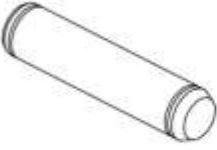
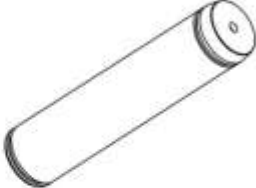

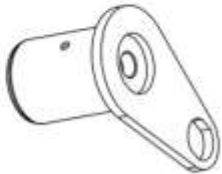
<p>BUCHA</p>  <p>D67061</p>	<p>BUCHA</p>  <p>D95362</p>	<p>BUCHA</p>  <p>D132076</p>	<p>BUCHA</p>  <p>D135739</p>
<p>BUCHA</p>  <p>D141075</p>	<p>BUCHA</p>  <p>D141076</p>	<p>BUCHA</p>  <p>D150121</p>	<p>BUCHA</p>  <p>D151034</p>
<p>BUCHA</p>  <p>D151071</p>	<p>BUCHA</p>  <p>E60864</p>	<p>BUCHA</p>  <p>E60865</p>	<p>BUCHA</p>  <p>E60866</p>
<p>BUCHA</p>  <p>E95946</p>	<p>BUCHA</p>  <p>E158734</p>	<p>BUCHA</p>  <p>G100495</p>	<p>BUCHA</p>  <p>G108512</p>
<p>BUCHA</p>  <p>J5428744</p>	<p>BUCHA</p>  <p>J5428744</p>	<p>BUCHA</p>  <p>K924148</p>	<p>BUCHA</p>  <p>L12570</p>





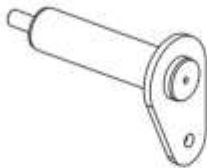
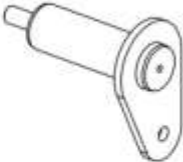
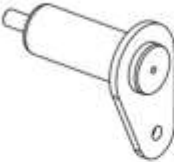
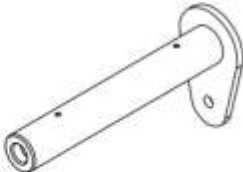
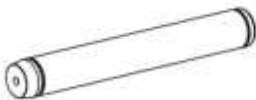





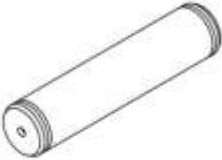
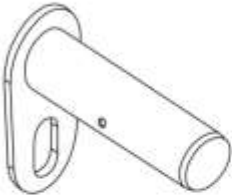
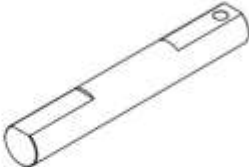

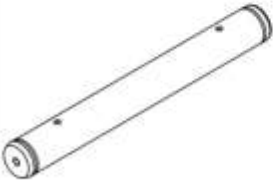
<p>BUCHA</p>  <p>L15802</p>	<p>BUCHA</p>  <p>L46480</p>	<p>BUCHA</p>  <p>L47305</p>	<p>BUCHA</p>  <p>L47306</p>
<p>BUCHA</p>  <p>L47560</p>	<p>BUCHA</p>  <p>L50464</p>	<p>BUCHA</p>  <p>L70757</p>	<p>BUCHA</p>  <p>L72204</p>
<p>BUCHA</p>  <p>L72998</p>	<p>BUCHA</p>  <p>L73170</p>	<p>BUCHA</p>  <p>L73230</p>	<p>BUCHA</p>  <p>L73525</p>
<p>BUCHA</p>  <p>L73527</p>	<p>BUCHA</p>  <p>L73569</p>	<p>BUCHA</p>  <p>L104286</p>	<p>BUCHA</p>  <p>L104342</p>
<p>BUCHA</p>  <p>L105142</p>	<p>BUCHA</p>  <p>L105144</p>	<p>BUCHA</p>  <p>L105214</p>	<p>BUCHA</p>  <p>L109938</p>

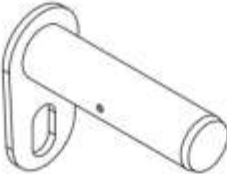

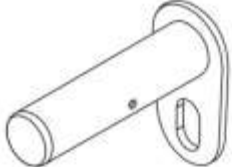

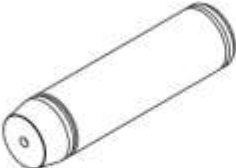
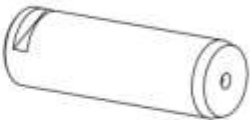

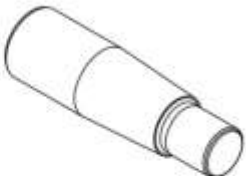
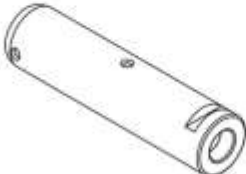

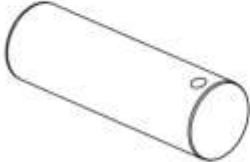
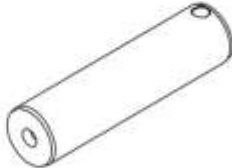

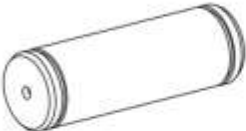

<p>BUCHA</p>  <p>L117068</p>	<p>BUCHA</p>  <p>L117143</p>	<p>BUCHA</p>  <p>L117465</p>	<p>BUCHA</p>  <p>L117466</p>
<p>BUCHA</p>  <p>L125227</p>	<p>BUCHA</p>  <p>L125229</p>	<p>BUCHA</p>  <p>L125957</p>	<p>BUCHA</p>  <p>L125972</p>
<p>BUCHA</p>  <p>L125973</p>	<p>BUCHA</p>  <p>L125974</p>	<p>BUCHA</p>  <p>L127014</p>	<p>BUCHA</p>  <p>L127015</p>
<p>RÓTULA</p>  <p>L17462</p>	<p>RÓTULA</p>  <p>L17463</p>	<p>ACOPLAMENTO</p>  <p>E95677</p>	<p>COROA</p>  <p>86700800</p>
<p>ARRUELA</p>  <p>D123684</p>	<p>ARRUELA</p>  <p>D72371</p>	<p>ARRUELA</p>  <p>L47700</p>	<p>PINO</p>  <p>518415</p>



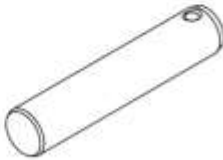

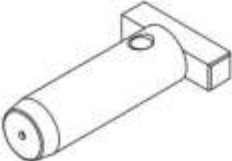

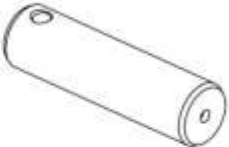
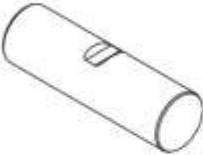
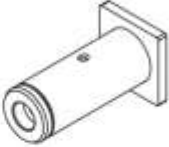

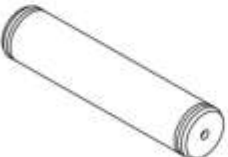
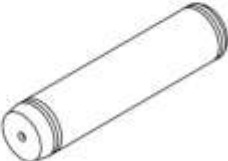

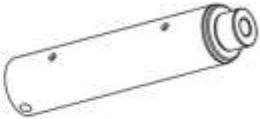

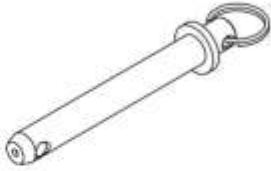

<p>PINO</p>  <p>7806066</p>	<p>PINO</p>  <p>8605835</p>	<p>PINO</p>  <p>84171217</p>	<p>PINO</p>  <p>84171343</p>
<p>PINO</p>  <p>84216891</p>	<p>PINO</p>  <p>84216892</p>	<p>PINO</p>  <p>84216893</p>	<p>PINO</p>  <p>84217317</p>
<p>PINO</p>  <p>84223653</p>	<p>PINO</p>  <p>84223654</p>	<p>PINO</p>  <p>84225660</p>	<p>PINO</p>  <p>84243665</p>
<p>PINO</p>  <p>84243667</p>	<p>PINO</p>  <p>84243668</p>	<p>PINO</p>  <p>84248656</p>	<p>PINO</p>  <p>84248744</p>
<p>PINO</p>  <p>84249274</p>	<p>PINO</p>  <p>84249275</p>	<p>PINO</p>  <p>84261887</p>	<p>PINO</p>  <p>84270815</p>



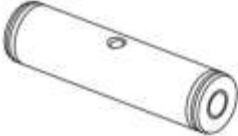

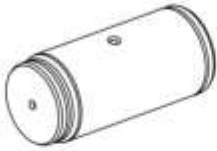
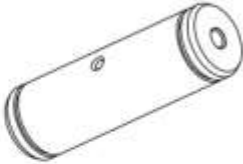
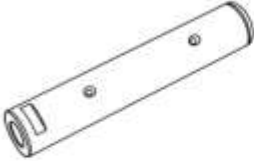
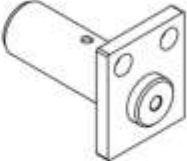
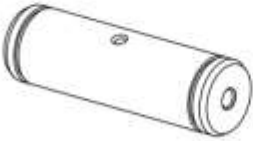





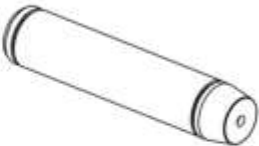
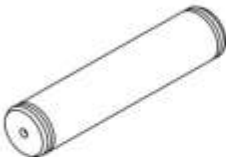

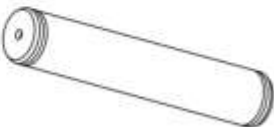
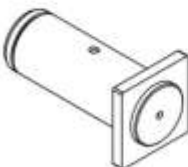
<p>PINO</p>  <p>84317391</p>	<p>PINO</p>  <p>84367828</p>	<p>PINO</p>  <p>84520512</p>	<p>PINO</p>  <p>86989400</p>
<p>PINO</p>  <p>87223565</p>	<p>PINO</p>  <p>87237359</p>	<p>PINO</p>  <p>87305263</p>	<p>PINO</p>  <p>87308973</p>
<p>PINO</p>  <p>87326813</p>	<p>PINO</p>  <p>87397343</p>	<p>PINO</p>  <p>87404197</p>	<p>PINO</p>  <p>87443401</p>
<p>PINO</p>  <p>87516018</p>	<p>PINO</p>  <p>100553A1/C</p>	<p>PINO</p>  <p>100553A1/P</p>	<p>PINO</p>  <p>104824A1</p>
<p>PINO</p>  <p>105749A1</p>	<p>PINO</p>  <p>105752A1</p>	<p>PINO</p>  <p>113629A1</p>	<p>PINO</p>  <p>111522A1</p>





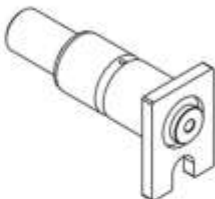
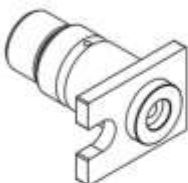

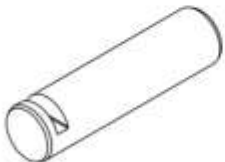
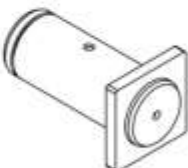

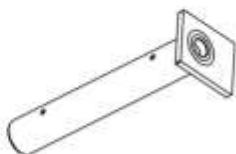

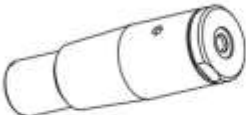
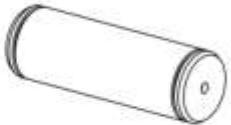

<p>PINO</p>  <p>116339A1</p>	<p>PINO</p>  <p>118900A1</p>	<p>PINO</p>  <p>118901A1</p>	<p>PINO</p>  <p>119129A1</p>
<p>PINO</p>  <p>121665A1</p>	<p>PINO</p>  <p>121779A1</p>	<p>PINO</p>  <p>129040A1</p>	<p>PINO</p>  <p>129041A1</p>
<p>PINO</p>  <p>132890A1</p>	<p>PINO</p>  <p>135247A1</p>	<p>PINO</p>  <p>138616A1</p>	<p>PINO</p>  <p>142842A1</p>
<p>PINO</p>  <p>146329A1</p>	<p>PINO</p>  <p>146334A1</p>	<p>PINO</p>  <p>146336A1</p>	<p>PINO</p>  <p>147058A1</p>
<p>PINO</p>  <p>148236A1</p>	<p>PINO</p>  <p>148346A1</p>	<p>PINO</p>  <p>292385A1</p>	<p>PINO</p>  <p>D26002</p>

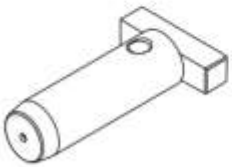



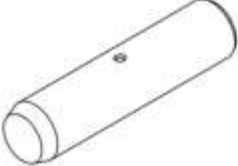
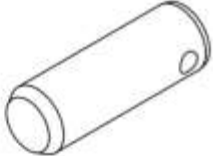

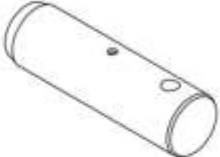
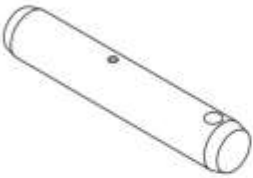
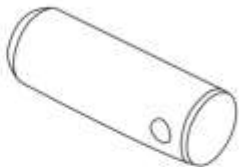
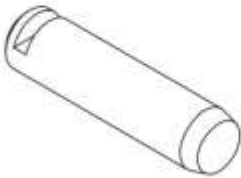

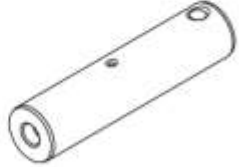

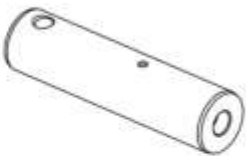

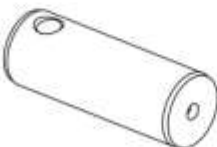
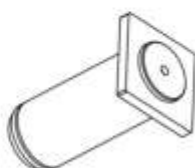
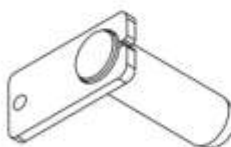

<p>PINO</p>  <p>300588A1</p>	<p>PINO</p>  <p>335177A1</p>	<p>PINO</p>  <p>361128A1</p>	<p>PINO</p>  <p>367184A1/P</p>
<p>PINO</p>  <p>375330A1</p>	<p>PINO</p>  <p>375328A1</p>	<p>PINO</p>  <p>378290A1</p>	<p>PINO</p>  <p>399607A1</p>
<p>PINO</p>  <p>411009A1</p>	<p>PINO</p>  <p>361139A2</p>	<p>PINO</p>  <p>361133A2</p>	<p>PINO</p>  <p>375326A2</p>
<p>PINO</p>  <p>386092A2</p>	<p>PINO</p>  <p>A17344</p>	<p>PINO</p>  <p>A17345</p>	<p>PINO</p>  <p>A17449</p>
<p>PINO</p>  <p>A17560</p>	<p>PINO</p>  <p>A17561</p>	<p>PINO</p>  <p>A63107</p>	<p>PINO</p>  <p>A76492</p>



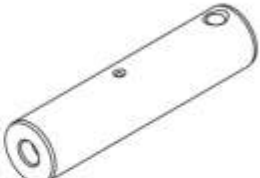

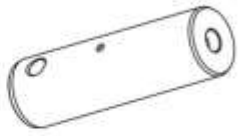
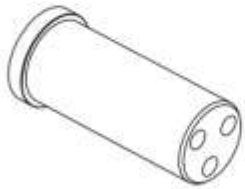





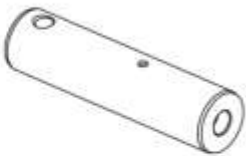

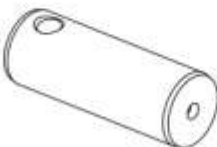

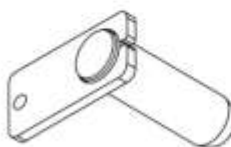
<p>PINO</p>  <p>D28648</p>	<p>PINO</p>  <p>D37614</p>	<p>PINO</p>  <p>D38907</p>	<p>PINO</p>  <p>D49865</p>
<p>PINO</p>  <p>D49866</p>	<p>PINO</p>  <p>D49879</p>	<p>PINO</p>  <p>D50696</p>	<p>PINO</p>  <p>D51391</p>
<p>PINO</p>  <p>D51393</p>	<p>PINO</p>  <p>D53818</p>	<p>PINO</p>  <p>D56335</p>	<p>PINO</p>  <p>D67759</p>
<p>PINO</p>  <p>D69588</p>	<p>PINO</p>  <p>D71927</p>	<p>PINO</p>  <p>D72337</p>	<p>PINO</p>  <p>D74004</p>
<p>PINO</p>  <p>D123865</p>	<p>PINO</p>  <p>D126718</p>	<p>PINO</p>  <p>D129227</p>	<p>PINO</p>  <p>D129256</p>



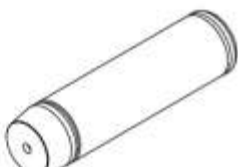
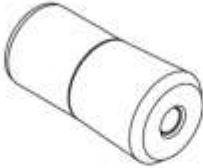
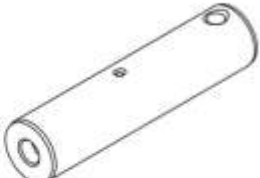

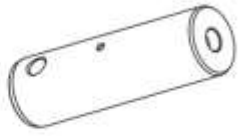
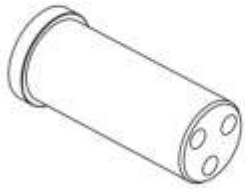





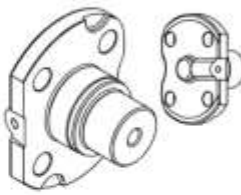





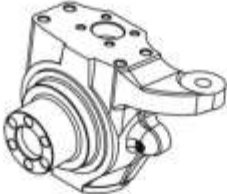

<p>PINO</p>  <p>D129257</p>	<p>PINO</p>  <p>D132494</p>	<p>PINO</p>  <p>D138038</p>	<p>PINO</p>  <p>D140247</p>
<p>PINO</p>  <p>D141142</p>	<p>PINO</p>  <p>D145767</p>	<p>PINO</p>  <p>D146288</p>	<p>PINO</p>  <p>D149033</p>
<p>PINO</p>  <p>D149239</p>	<p>PINO</p>  <p>D149298</p>	<p>PINO</p>  <p>D150155</p>	<p>PINO</p>  <p>D150619</p>
<p>PINO</p>  <p>D151065</p>	<p>PINO</p>  <p>E41415</p>	<p>PINO</p>  <p>E60223</p>	<p>PINO</p>  <p>E60871</p>
<p>PINO</p>  <p>E62638</p>	<p>PINO</p>  <p>E62710</p>	<p>PINO</p>  <p>E62723</p>	<p>PINO</p>  <p>E62735</p>

<p>PINO</p>  <p>E62736</p>	<p>PINO</p>  <p>E62737</p>	<p>PINO</p>  <p>E62795</p>	<p>PINO</p>  <p>E62796</p>
<p>PINO</p>  <p>E62797</p>	<p>PINO</p>  <p>E62798</p>	<p>PINO</p>  <p>E62800</p>	<p>PINO</p>  <p>E62802</p>
<p>PINO</p>  <p>E62803</p>	<p>PINO</p>  <p>E62804</p>	<p>PINO</p>  <p>E62805</p>	<p>PINO</p>  <p>E62806</p>
<p>PINO</p>  <p>E62808</p>	<p>PINO</p>  <p>E63980</p>	<p>PINO</p>  <p>E63982</p>	<p>PINO</p>  <p>E64038</p>
<p>PINO</p>  <p>E64320</p>	<p>PINO</p>  <p>E64340</p>	<p>PINO</p>  <p>E64343</p>	<p>PINO</p>  <p>E65357</p>

<p>PINO</p>  <p>E65860</p>	<p>PINO</p>  <p>E66074</p>	<p>PINO</p>  <p>E66294</p>	<p>PINO</p>  <p>E69422</p>
<p>PINO</p>  <p>E69606</p>	<p>PINO</p>  <p>E96436</p>	<p>PINO</p>  <p>E96620</p>	<p>PINO</p>  <p>E96632</p>
<p>PINO</p>  <p>E155088</p>	<p>PINO</p>  <p>E157390</p>	<p>PINO</p>  <p>E158925</p>	<p>PINO</p>  <p>E159033</p>
<p>PINO</p>  <p>E159035</p>	<p>PINO</p>  <p>E159036</p>	<p>PINO</p>  <p>E159037</p>	<p>PINO</p>  <p>E159038</p>
<p>PINO</p>  <p>E159043</p>	<p>PINO</p>  <p>E159047</p>	<p>PINO</p>  <p>E159050</p>	<p>PINO</p>  <p>L15725</p>

<p>PINO</p>  <p>L15800</p>	<p>PINO</p>  <p>L40421</p>	<p>PINO</p>  <p>L47562</p>	<p>PINO</p>  <p>L47564</p>
<p>PINO</p>  <p>L47952</p>	<p>PINO</p>  <p>L70331</p>	<p>PINO</p>  <p>L70534</p>	<p>PINO</p>  <p>L72169</p>
<p>PINO</p>  <p>L72222</p>	<p>PINO</p>  <p>L73076</p>	<p>PINO</p>  <p>L73651</p>	<p>PINO</p>  <p>L74482</p>
<p>PINO</p>  <p>L77373</p>	<p>PINO</p>  <p>L100624</p>	<p>PINO</p>  <p>L104347</p>	<p>PINO</p>  <p>L109584</p>
<p>PINO</p>  <p>L125226</p>	<p>PINO</p>  <p>L125271</p>	<p>PINO</p>  <p>L128351</p>	<p>PINO</p>  <p>L129129</p>

<p>PINO</p>  <p>L15800</p>	<p>PINO</p>  <p>L40421</p>	<p>PINO</p>  <p>L47562</p>	<p>PINO</p>  <p>L47564</p>
<p>PINO</p>  <p>L47952</p>	<p>PINO</p>  <p>L70331</p>	<p>PINO</p>  <p>L70534</p>	<p>PINO</p>  <p>L72169</p>
<p>PINO</p>  <p>L72222</p>	<p>PINO</p>  <p>L73076</p>	<p>PINO</p>  <p>L73651</p>	<p>PINO</p>  <p>L74482</p>
<p>PINO</p>  <p>L77373</p>	<p>PINO</p>  <p>L100624</p>	<p>PINO</p>  <p>L104347</p>	<p>PINO</p>  <p>L109584</p>
<p>PINO</p>  <p>L125226</p>	<p>PINO</p>  <p>L125271</p>	<p>PINO</p>  <p>L128351</p>	<p>PINO</p>  <p>L129129</p>

<p>PIVÔ (FORJADO)</p>  <p>122264A1</p>	<p>PIVÔ (FORJADO)</p>  <p>122265A1</p>	<p>EIXO CASE</p>  <p>L47565</p>	<p>CARCAÇA DA ARTICULAÇÃO</p>  <p>144455A1 LE</p>
<p>CARCAÇA DA ARTICULAÇÃO</p>  <p>144456A1 LD</p>	<p>CARCAÇA DA ARTICULAÇÃO</p>  <p>397653A1 LE</p>	<p>CARCAÇA DA ARTICULAÇÃO</p>  <p>397654A1 LD</p>	<p>CARCAÇA DE ARTICULAÇÃO</p>  <p>87710156 LE</p>
<p>CARCAÇA DE ARTICULAÇÃO</p>  <p>87710159 LD</p>	<p>SUPORTE DO PLANETÁRIO</p>  <p>100553A1</p>	<p>SUPORTE DO PLANETÁRIO</p>  <p>292891A1</p>	<p>CUBO</p>  <p>144466A1</p>
<p>ESPAÇADOR</p>  <p>450674A1</p>	<p>ENGRENAGEM</p>  <p>6914500</p>	<p>ENGRENAGEM</p>  <p>87223440</p>	<p>ENGRENAGEM</p>  <p>133742637</p>
<p>ENGRENAGEM</p>  <p>100562A1</p>	<p>ENGRENAGEM</p>  <p>175979A1</p>	<p>ENGRENAGEM</p>  <p>1537650C1</p>	<p>FLANGE</p>  <p>87241854</p>

<p>FLANGE</p>  <p>87244744</p>	<p>FLANGE</p>  <p>D50075</p>	<p>FLANGE</p>  <p>J905820</p>	<p>PINHÃO</p>  <p>86701200</p>
<p>PINHÃO</p>  <p>87223444</p>	<p>GRUPOS PARA ESTEIRAS</p>  <p>GR CX36 GR CX220</p>		

BUCHAS PARA MÁQUINAS CASE



81802789	D38943	D31140	D66651	D151074	D150122	L70269
107124A1	D52521	D42788	D43946	D129264	D33024	84326305
D135559	E97060	D60159	D31511	D127507	D44549	D127542
D30929	123407A1	G103411	D43508	D151070	D69221	D151073
D37495	E60862	84229922	D65932	D50337	L17466	D34340
D51545	D33023	E65951	G34875	D37443	84244078	
E66022	D145978	D140029	84231081	D30756	D127172	
81802836	192559A1	D31142	A12058	84247142	D151069	
109268A1	84230813	D43223	D149079	D135557	D33047	
D135741	D137345	D65731	D31512	100696A1	D44648	
D30930	D30933	G32050	D43940	L72202	D69222	
D37763	D40243	D127167	D66640	E63559	D50146	
D52434	D55626	D149726	G35396	D44543	D37392	
E66031	E158752	D46405	84235607	D67150	D49429	
84170645	84226810	84240578	A75651	G35418	E60863	
D137218	135248A1	G35413	D149725	84244076	L70270	
D30932	D138047	D34109	D32865	D127168	84326988	

CONJUNTO DO ENGATE PARA MÁQUINA CASE

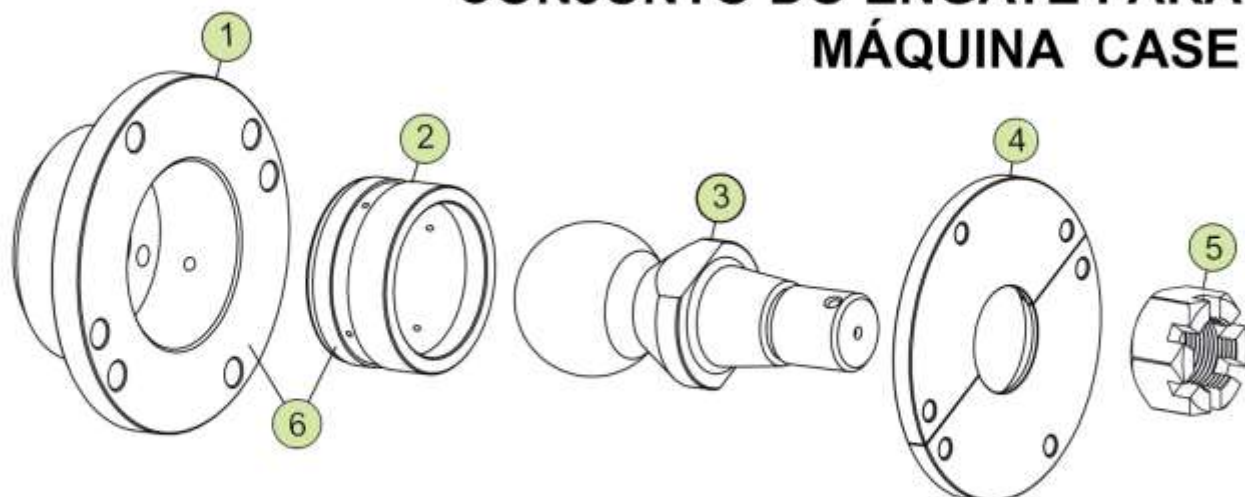

CUBO DE FIXAÇÃO

91201043

BUCHA DE APOIO

91400038

FLANGE BIPARTIDO

91400040

PINO

91400037

CUBO COMPLETO

91201061

PORCA

943501

ACOMPANHA

POS.	QTD.	DESCRIÇÃO
1	01	Cubo de Fixação
2	01	Bucha de Apoio
3	01	Pino
4	01	Flange Nipartido
5	01	Porca
6	01	Cubo Completo

EIXO DA SUSPENSÃO COMPLETO COLHEDORA PARA MÁQUINA CASE

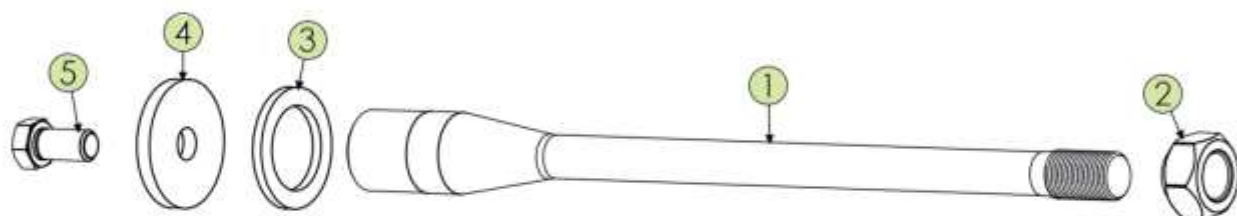

ESPAÇADOR

450674A1

PORCA

449257A1

EIXO

87443401

ARRUELA

449258A1

PARAFUSO

FA110020

ACOMPANHA

POS.	QTD.	DESCRIÇÃO
1	01	Eixo
2	01	Porca
3	01	Espaçador
4	01	Arruela
5	01	Parafuso

KIT - 580H TRASEIRO (KT 580H T)

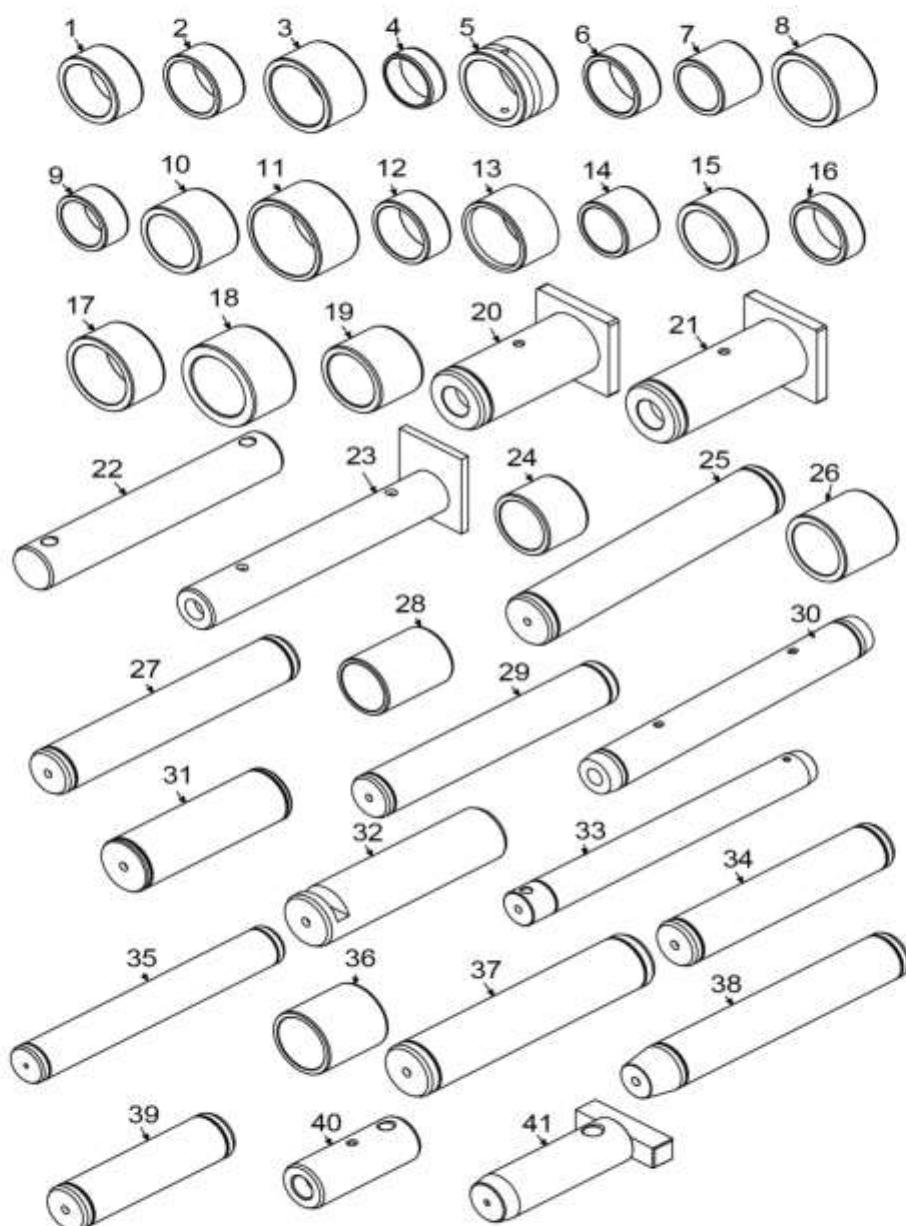

POS.	CÓDIGO
1	D43940
2	D34340
3	D43946
4	D50337
5	E95946
6	D33047
7	D30929
8	D31142
9	D32865
10	D50146
11	D60159
12	G34854
13	G34875
14	D30933
15	D37495
16	D46405
17	D30756
18	D50698
19	D55626
20	E64340
21	E62800
22	D49865
23	E65357
24	D49429
25	E62804
26	D37443
27	E62798
28	D37450
29	E62806
30	E62808
31	E62802
32	E64320
33	E64343
34	E62795
35	E69606
36	D42788
37	E62803
38	E62805
39	E62796
40	D49866
41	E96620

KIT - 580H DIANTEIRO

(KT 580H D)

POS.	CÓDIGO
1	G35396
2	D65932
3	D30933
4	D30929
5	D67150
6	D69221
7	D69222
8	E41415
9	D71927
10	E62737
11	E62710
12	D72337
13	E62723
14	E62735
15	D72371
16	D45904
17	D31219
18	D67061

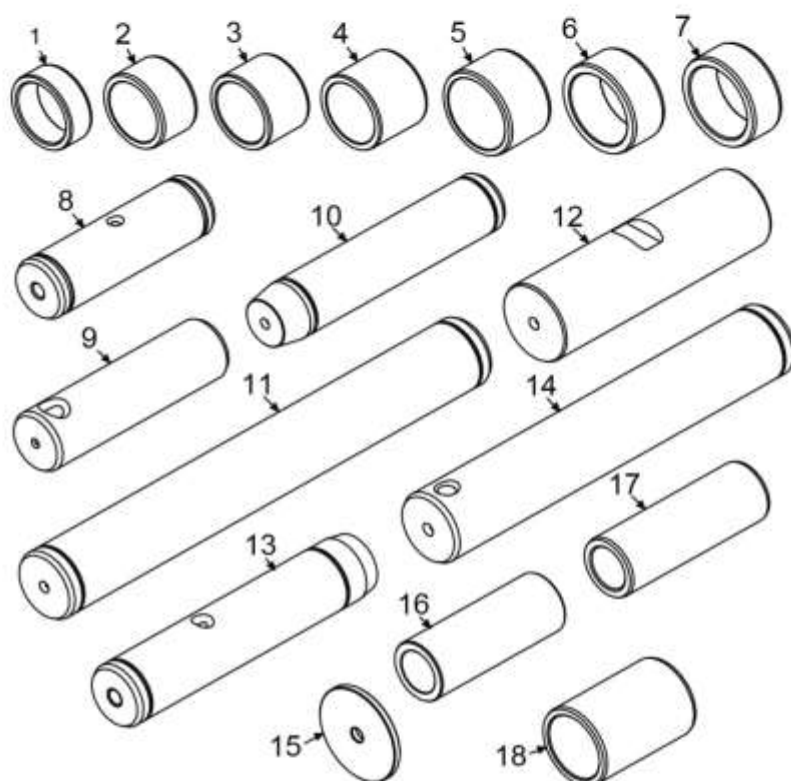

KIT - 580H DIANTEIRO

(KT 580H D)

POS.	CÓDIGO
1	G35396
2	D65932
3	D30933
4	D30929
5	D67150
6	D69221
7	D69222
8	E41415
9	D71927
10	E62737
11	E62710
12	D72337
13	E62723
14	E62735
15	D72371
16	D45904
17	D31219
18	D67061

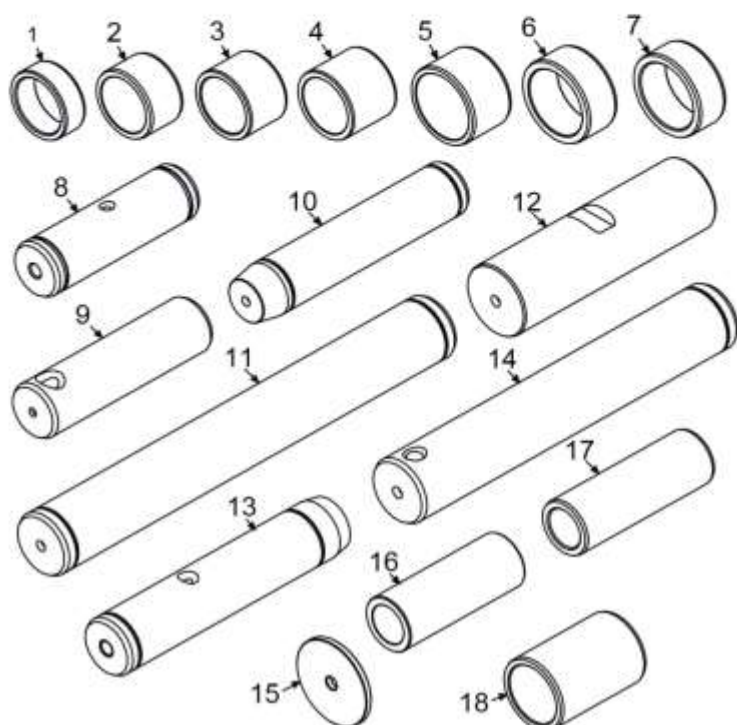

KIT - 580H EIXO DIANTEIRO

(KT 580H E)

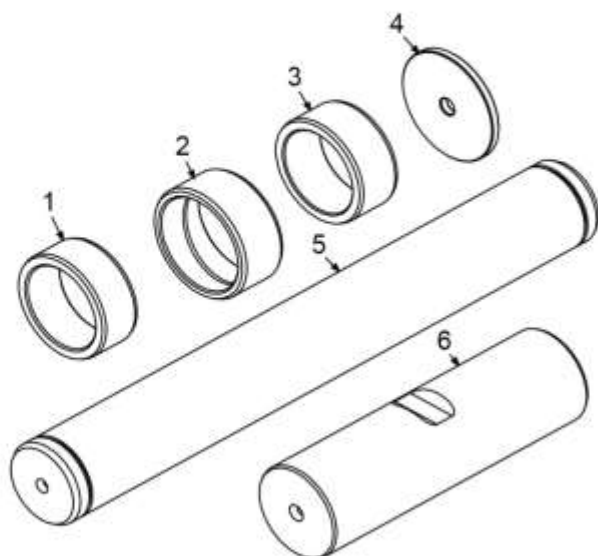

POS.	CÓDIGO
1	D69222
2	A28230
3	D69221
4	D72371
5	E62710
6	D72337

KIT - 580H EIXO DIANTEIRO SUPER (KT 580H E SUPER)

POS.	CÓDIGO
1	D72371
2	A28230
3	D127507
4	D137345
5	D138047
6	138616A1
7	D123865
8	D150155

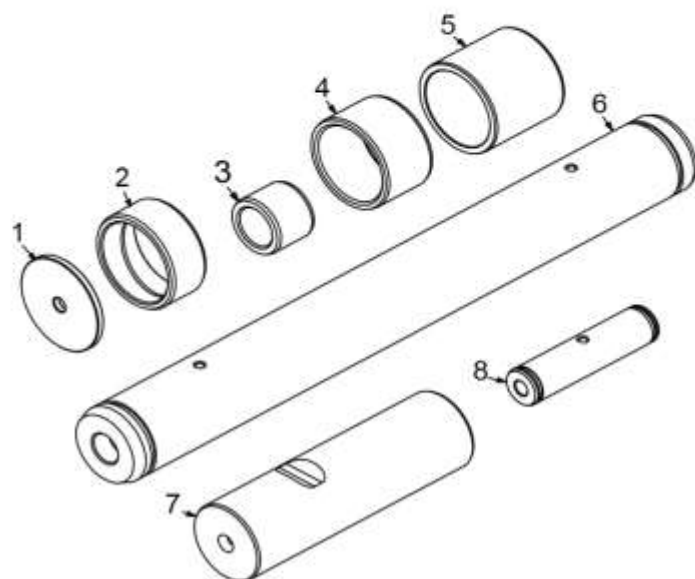

KIT - 580H DIANTEIRO SUPER (KT 580H D SUPER)

POS.	CÓDIGO
1	G35396
2	D31511
3	D65932
4	D37763
5	D30933
6	D30929
7	D31512
8	D45904
9	D31219
10	D67061
11	E62723
12	E62737
13	D71927
14	E155088
15	E62735
16	E41415
17	D67150

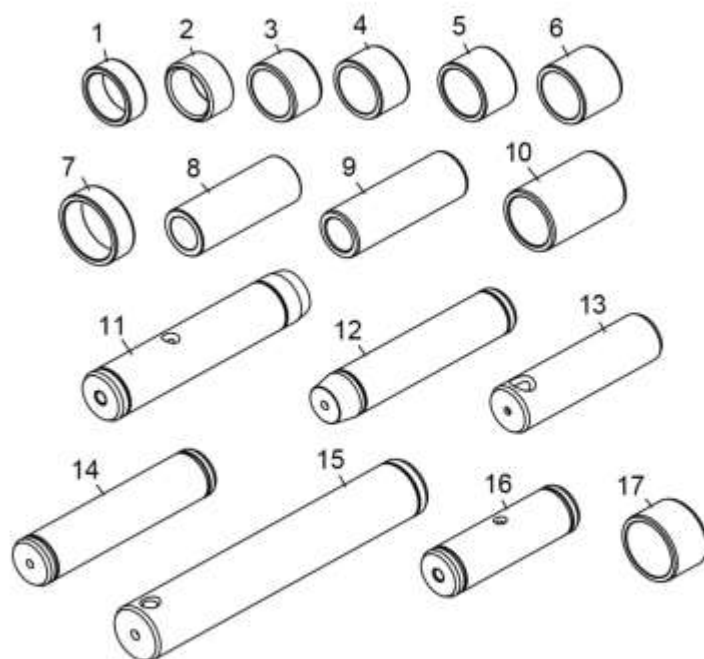

KIT - 580H TRASEIRO SUPER (KT 580H T SUPER)

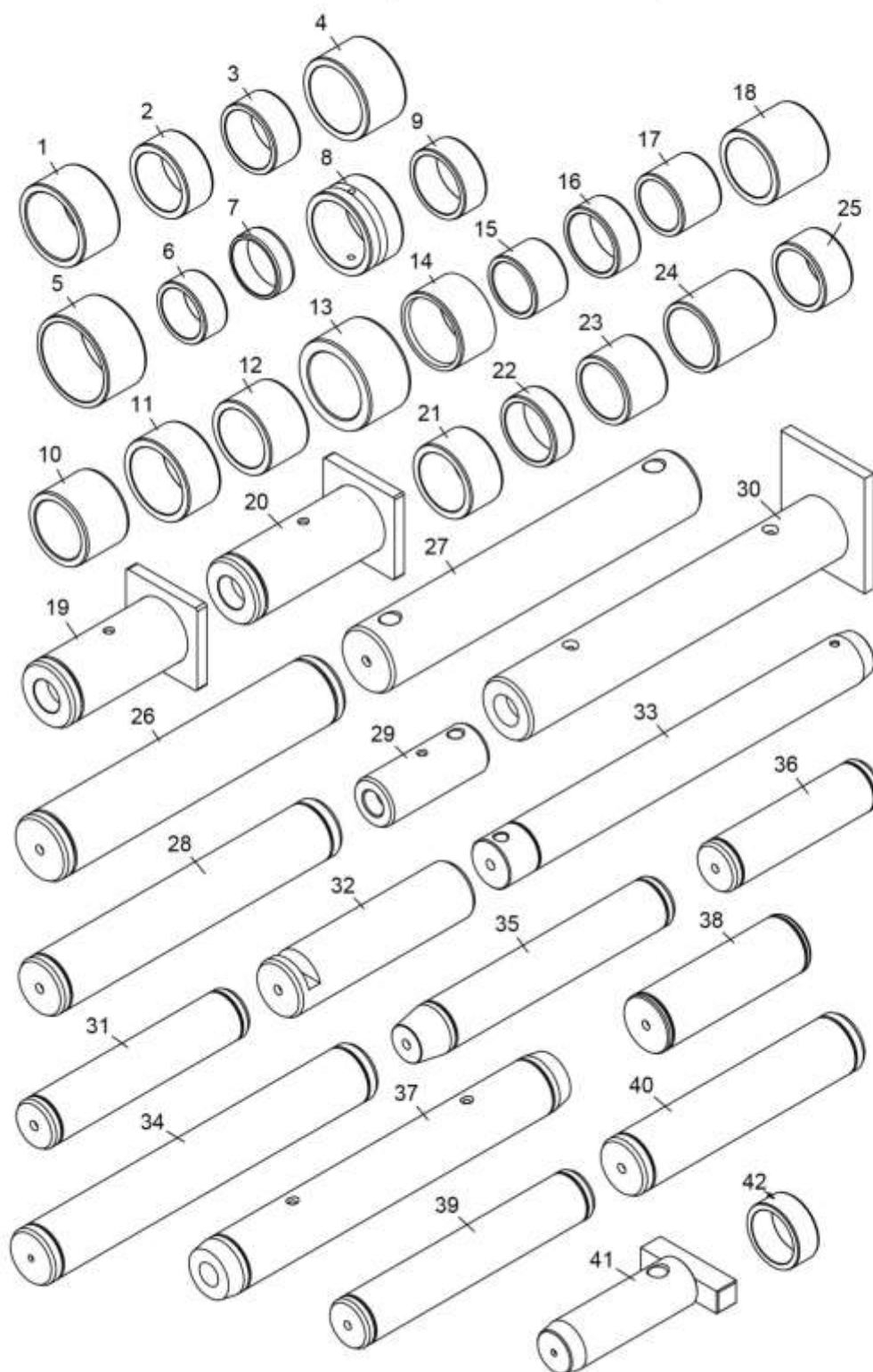

POS.	CÓDIGO
1	D43946
2	D43940
3	D34340
4	D31142
5	D60159
6	D32865
7	D50337
8	E95946
9	G34854
10	D55626
11	D30756
12	D50146
13	D50698
14	G34875
15	D30933
16	D33047
17	D30929
18	D37443
19	E64340
20	E62800
21	D37495
22	D46405
23	D49429
24	D42788
25	D31140
26	E62804
27	D49865
28	E62806
29	D49866
30	E65357
31	E62795
32	E64320
33	E64343
34	E69606
35	E62805
36	E62796
37	E62808
38	E62802
39	E62798
40	E62803
41	E96620
42	D33024

KIT - 580H TRASEIRO MODERNO

(KT 580H T MOD)

POS.	CÓDIGO
1	D43940
2	D34340
3	D43946
4	D50337
5	E95946
6	D33047
7	D30929
8	D31142
9	D32865
10	D50146
11	D60159
12	G34854
13	G34875
14	D30933
15	D37495
16	D46405
17	D30756
18	D50698
19	D55626
20	E64340
21	E62800
22	D49865
23	E65860
24	D49429
25	E62804
26	D37443
27	E62798 LONGO
28	D37450
29	E62806
30	E62808
31	E62802
32	E64320
33	E64343
34	E62795
35	E69606
36	D42788
37	E62803
38	E62805
39	E62796
40	D49866
41	E96620

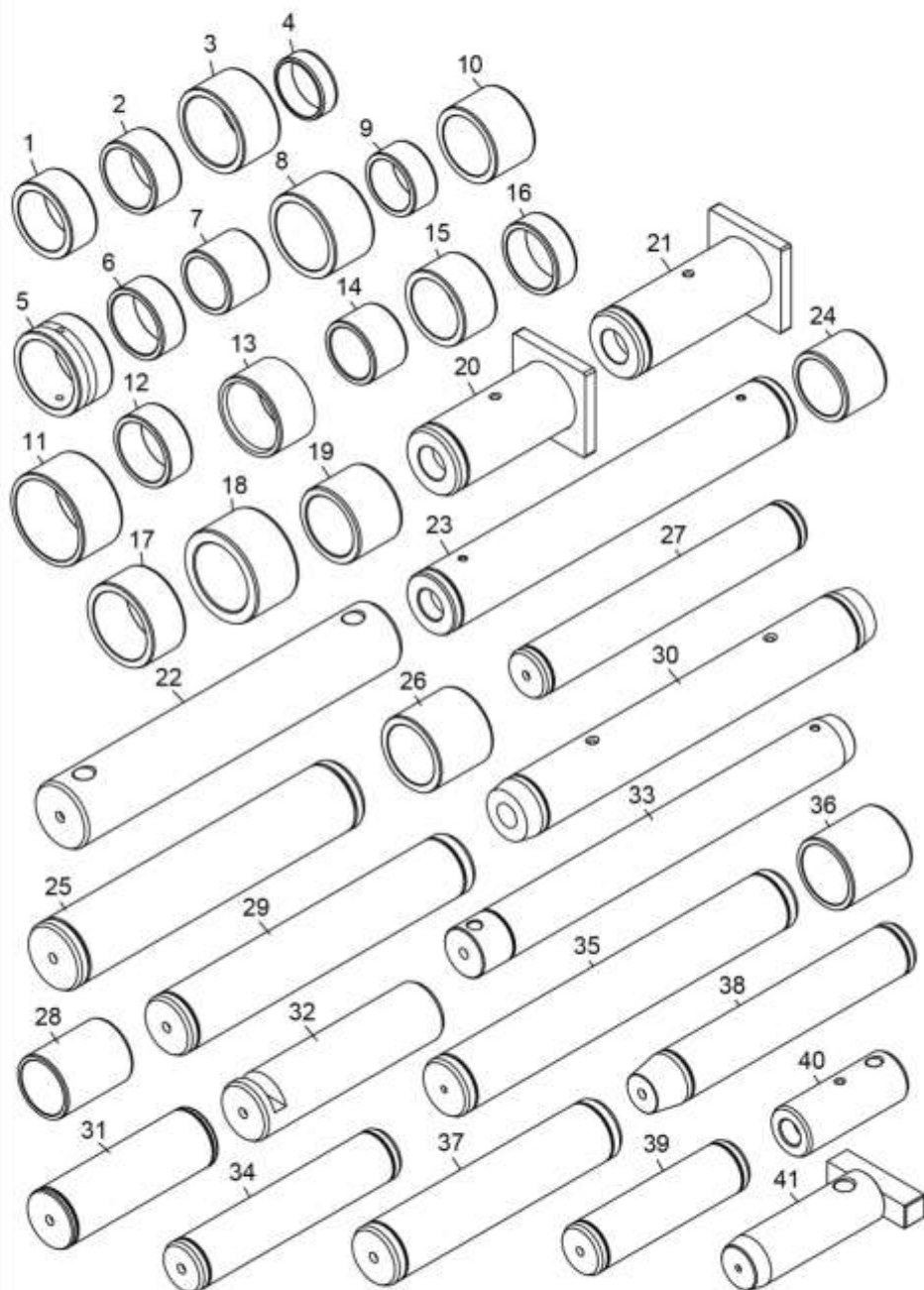

KIT - 580L DIANTEIRO

(KT 580L D)

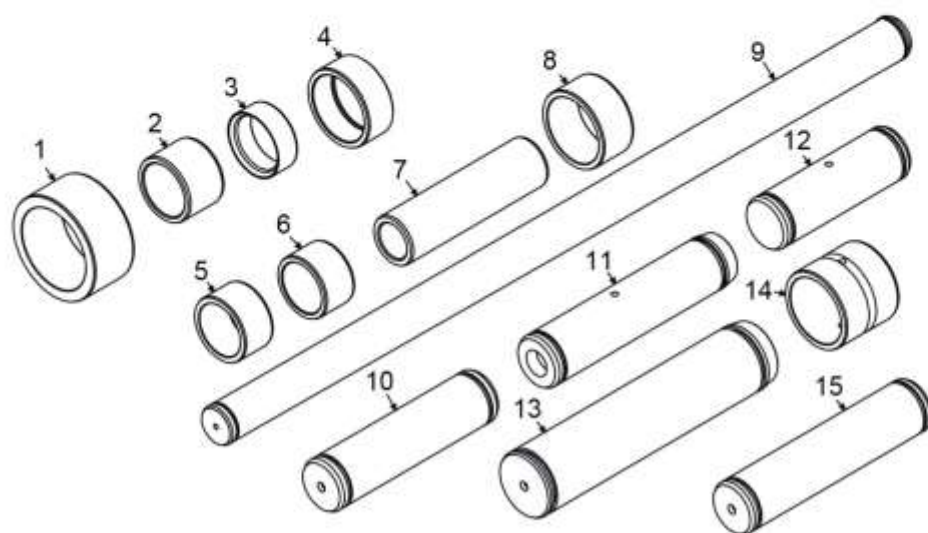

POS.	CÓDIGO
1	D137218
2	109268A1
3	G108512
4	D151034
5	D129264
6	100696A1
7	D132076
8	D127542
9	D145767
10	113629A1
11	118901A1
12	116339A1
13	119129A1
14	180427A1
15	118900A1

KIT - 580L EIXO DIANTEIRO

(KT 580L E)

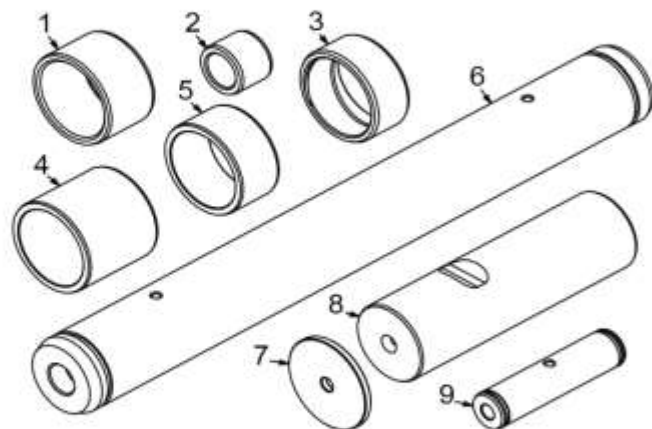

POS.	CÓDIGO
1	D137345
2	D127507
3	A28230
4	D138047
5	D127542
6	138616A1
7	D72371
8	D123865
9	D150155

KIT - 580L TRASEIRO SÉRIE I

(KT 580L SERIE I)

POS.	CÓDIGO
1	D31140
2	107124A1
3	D37495
4	135249A1
5	D140029
6	D50146
7	D127167
8	D150122
9	D145978
10	D151069
11	D135557
12	D151074
13	D151073
14	D151070
15	D138047
16	D149079
17	137248A1
18	124568A2
19	192559A1
20	D151071
21	D150121
22	121778A1
23	D137218
24	121779A1
25	D132494
26	D151065
27	132890A1
28	114318A1
29	D127172
30	135247A1
31	D37614
32	D26002
33	D146288
34	121665A1
35	D150619
36	142842A1
37	D30933
38	D28648
39	D141142
40	D38907
41	129040A1
42	129041A1
43	D127168
44	D135559
45	135248A1
46	D135739
47	D135741

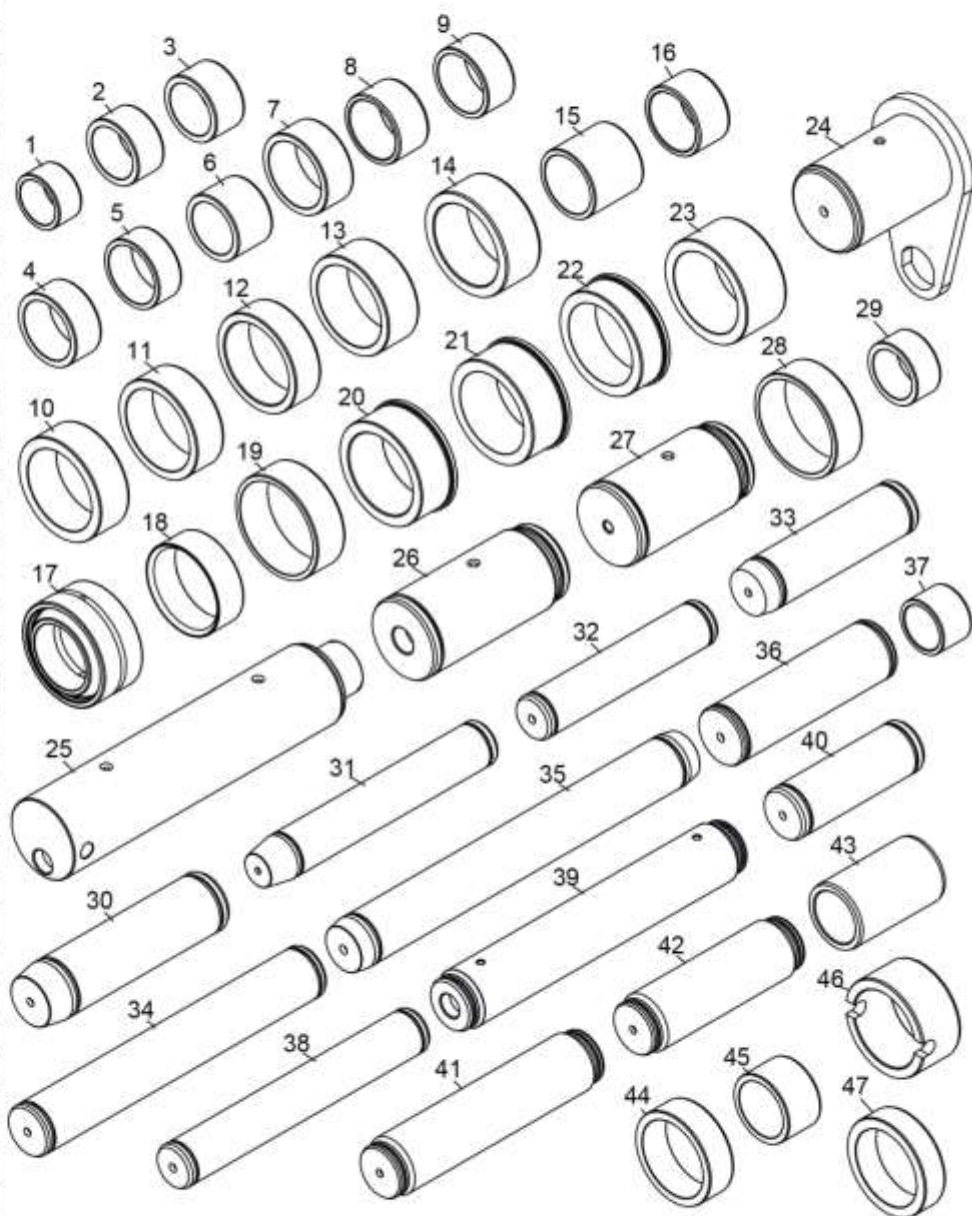

KIT - 580L TRASEIRO SÉRIE II (KT 580L SERIE II)

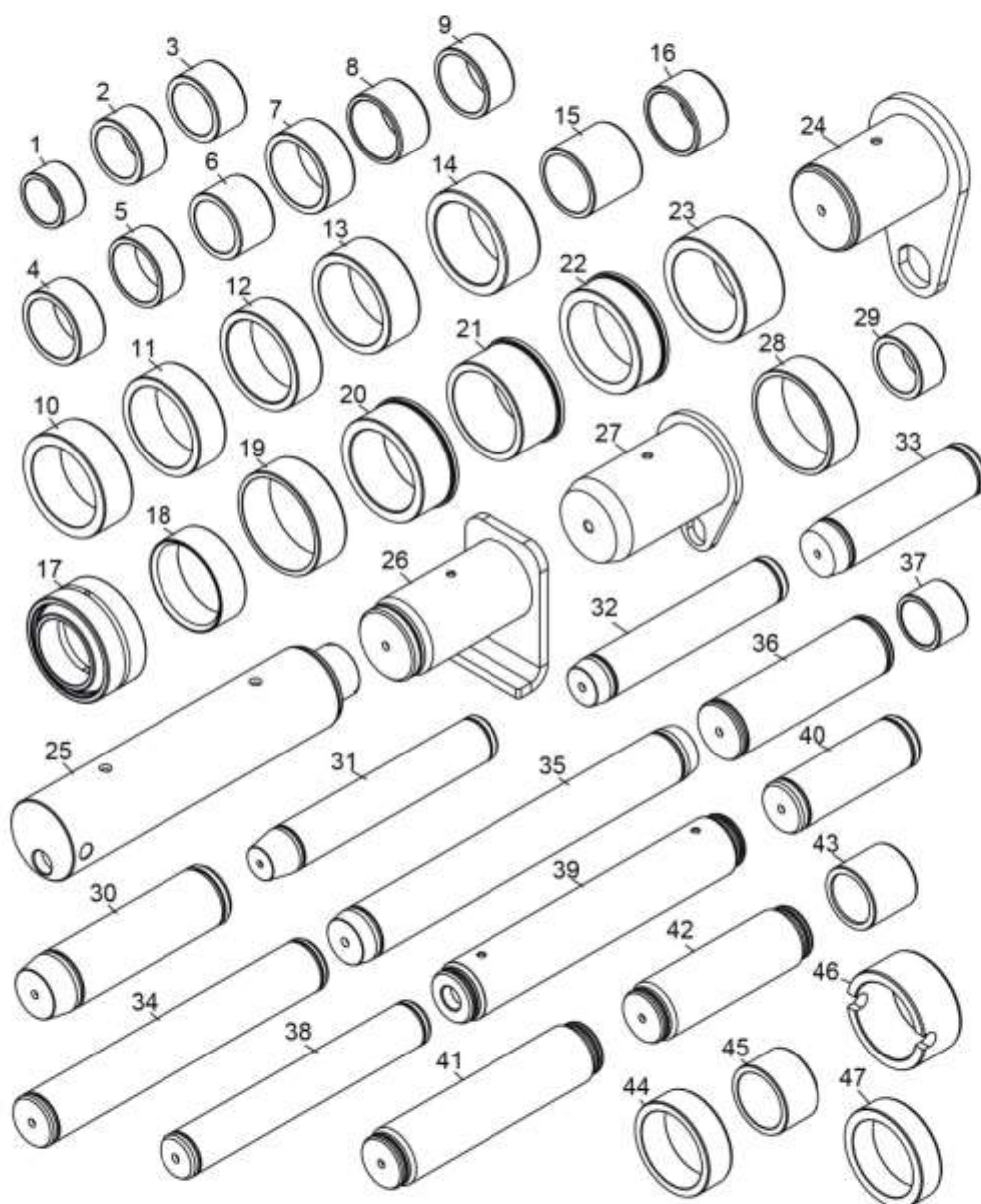

POS.	CÓDIGO
1	D31140
2	107124A1
3	D37495
4	135249A1
5	D140029
6	D50146
7	D127167
8	D150122
9	D145978
10	D151069
11	D135557
12	D151074
13	D151073
14	D151070
15	D138047
16	D149079
17	137248A1
18	124568A2
19	192559A1
20	D151071
21	75261187
22	121778A1
23	D137218
24	121779A1
25	D132494
26	148687A1
27	148694A1
28	114318A1
29	D127172
30	135247A1
31	D37614
32	148346A1
33	D146288
34	121665A1
35	D150619
36	142842A1
37	D30933
38	D28648
39	D141142
40	D38907
41	129040A1
42	129041A1
43	75260976
44	D135559
45	135248A1
46	D135739
47	D135741

KIT - 580L TRASEIRO FASE I (KT 580L T)

POS.	CÓDIGO
1	D31140
2	107124A1
3	D37495
4	135249A1
5	D140029
6	D50146
7	D127167
8	D150122
9	D145978
10	D151069
11	D135557
12	D151074
13	D151073
14	D151070
15	D138047
16	D149079
17	D127168
18	124568A2
19	192559A1
20	D151071
21	D150121
22	121778A1
23	D137218
24	121779A1
25	D132494
26	132890A1
27	D151065
28	114318A1
29	D127172
30	135247A1
31	D37614
32	D26002
33	D146288
34	121665A1
35	D150619
36	142842A1
37	D30933
38	D28648
39	D141142
40	D38907
41	129040A1
42	129041A1
43	D135739
44	D135559
45	135248A1
46	D135741

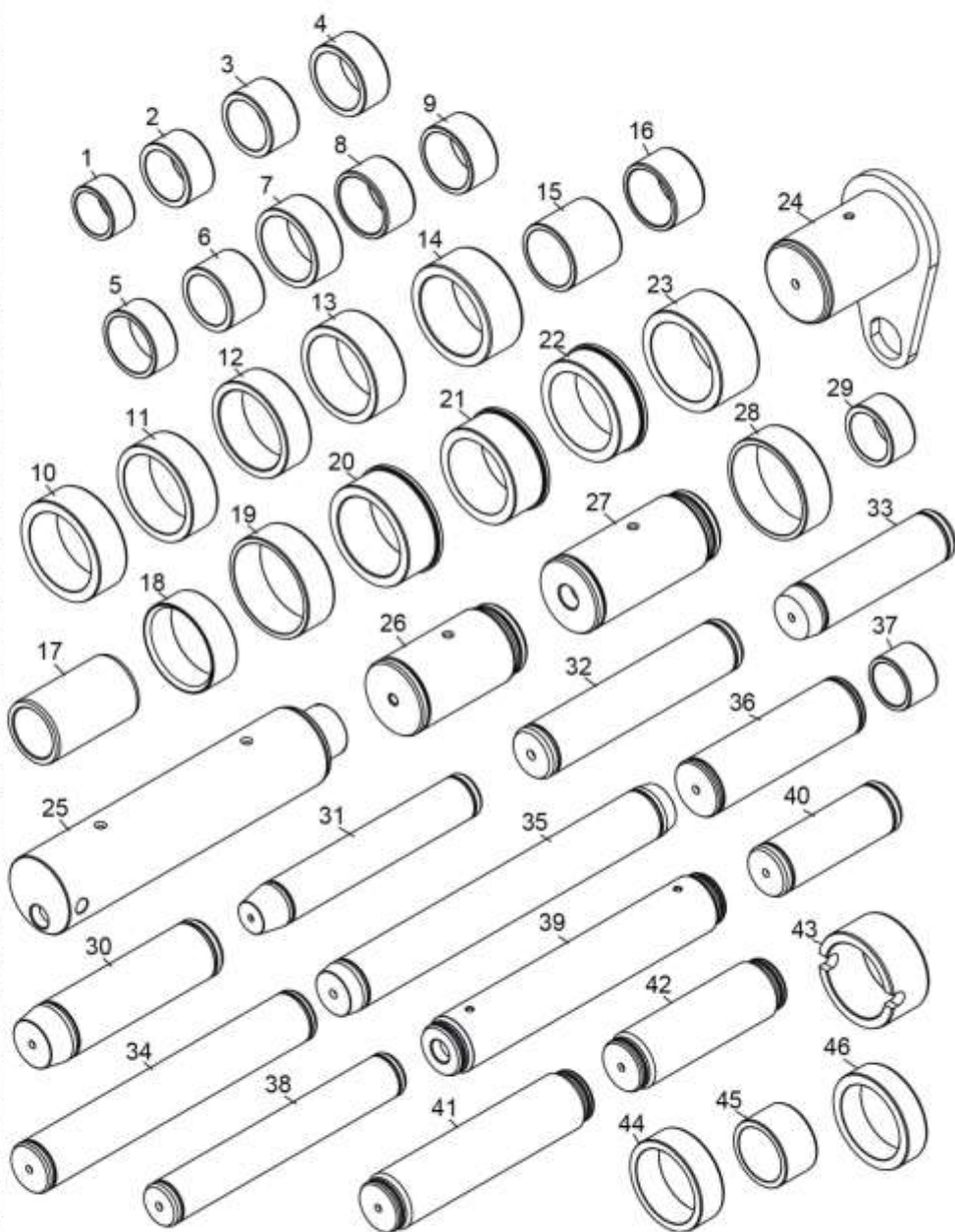

KIT - 580L TRASEIRO FASE II (KT 580L T 2)

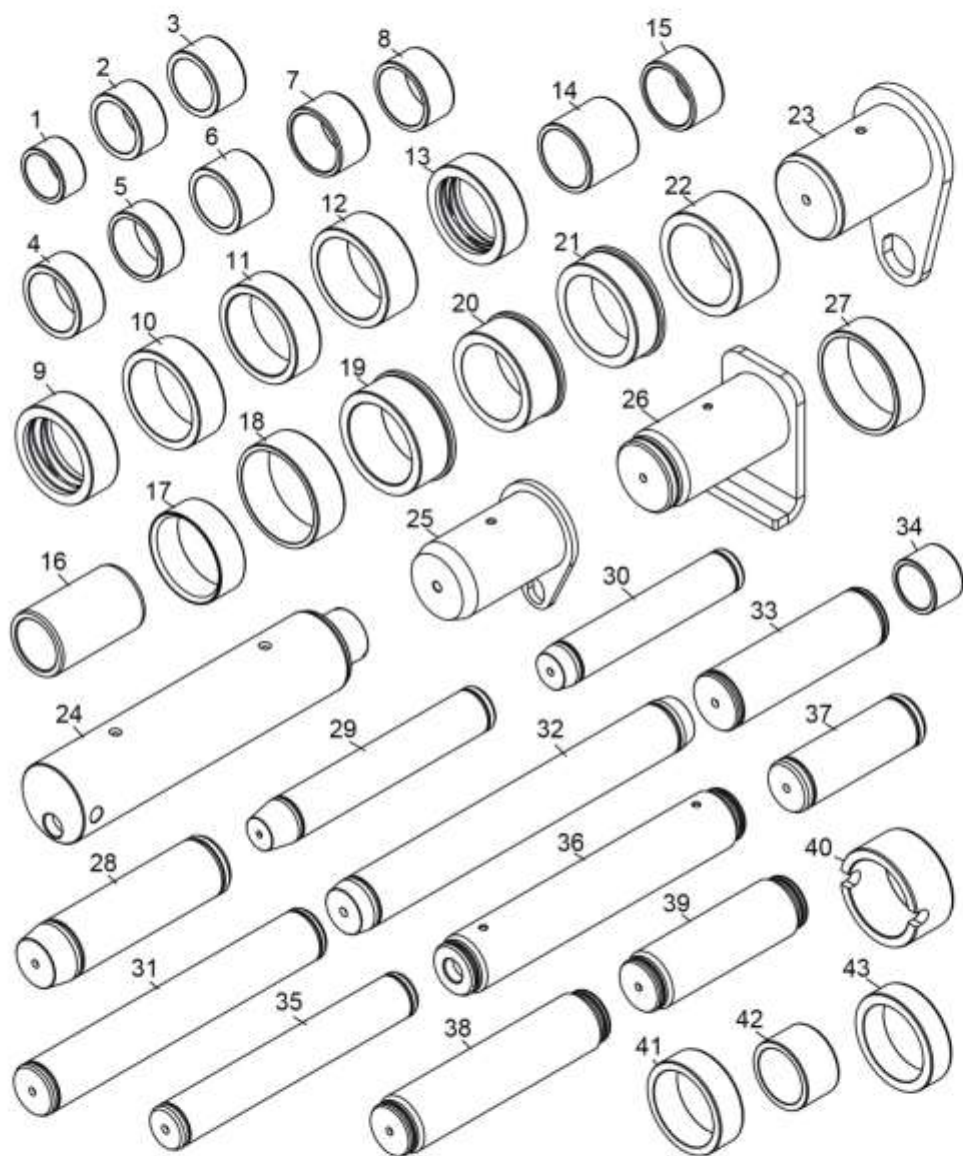

POS.	CÓDIGO
1	D31140
2	107124A1
3	D37495
4	135249A1
5	D140029
6	D50146
7	D150122
8	D145978
9	148657A1
10	D135557
11	D151074
12	D151073
13	148658A1
14	D138047
15	D149079
16	D127168
17	124568A2
18	192559A1
19	D151071
20	D150121
21	121778A1
22	D137218
23	121779A1
24	D132494
25	148694A1
26	148687A1
27	114318A1
28	135247A1
29	D37614
30	148346A1
31	121665A1
32	D150619
33	142842A1
34	D30933
35	D28648
36	D141142
37	D38907
38	129040A1
39	129041A1
40	D135739
41	D135559
42	135248A1
43	D135741

KIT - 580L TRASEIRO FASE III (KT 580L T 3)

POS.	CÓDIGO
1	D31140
2	107124A1
3	D37495
4	135249A1
5	75261188
6	D50146
7	D150122
8	D145978
9	137248A1
10	D135557
11	D151074
12	D151073
13	D151070
14	D138047
15	D149079
16	75260976
17	124568A2
18	192559A1
19	D151071
20	75261187
21	121778A1
22	D151069
23	121779A1
24	D132494
25	148694A1
26	148687A1
27	114318A1
28	D37614
29	148346A1
30	121665A1
31	D150619
32	142842A1
33	D30933
34	D28648
35	D141142
36	D38907
37	129040A1
38	129041A1
39	D135739
40	D135559
41	135248A1
42	D135741
43	135247A1

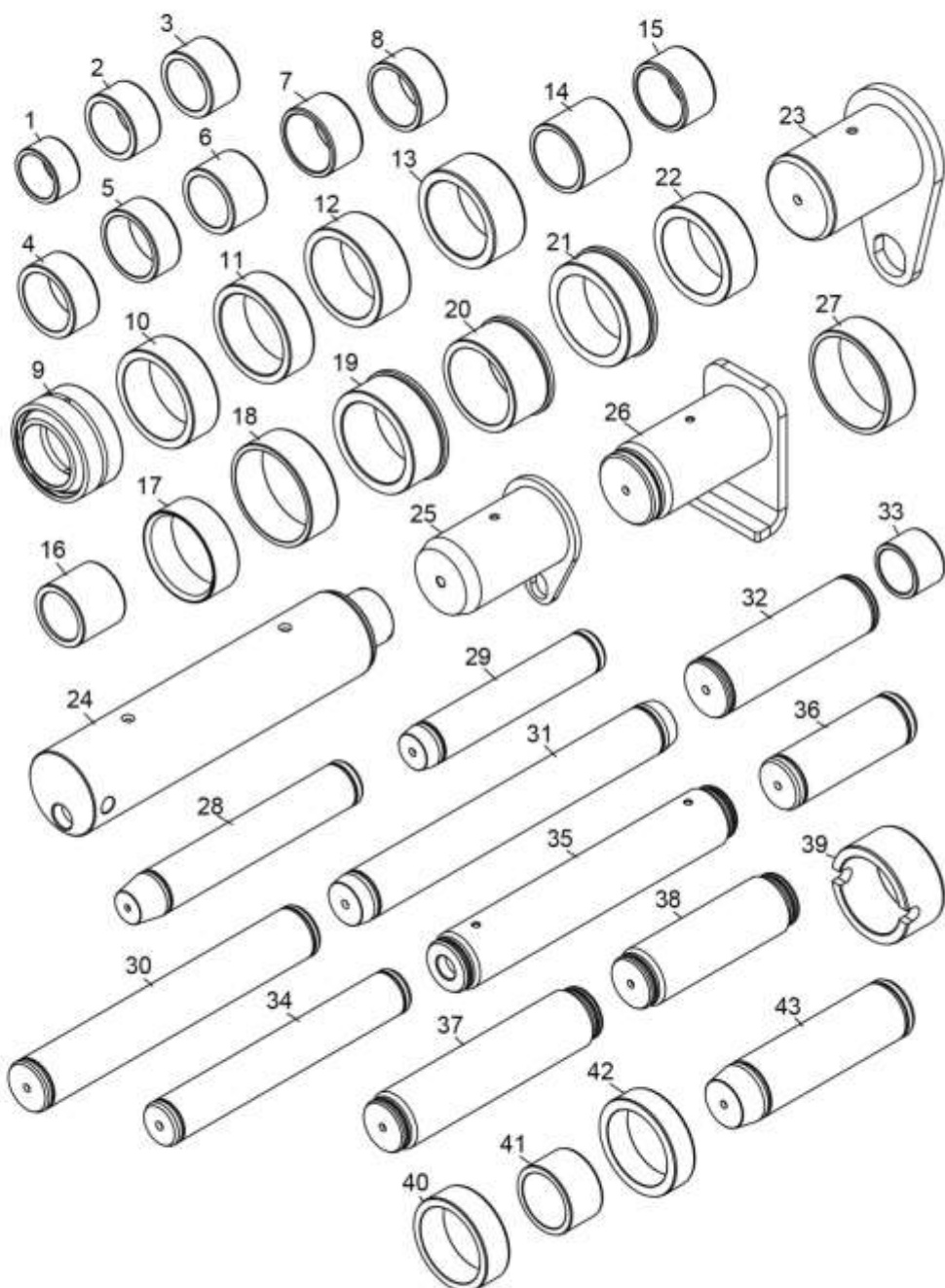

KIT - 580M EIXO DIANTEIRO (KT 580M E)

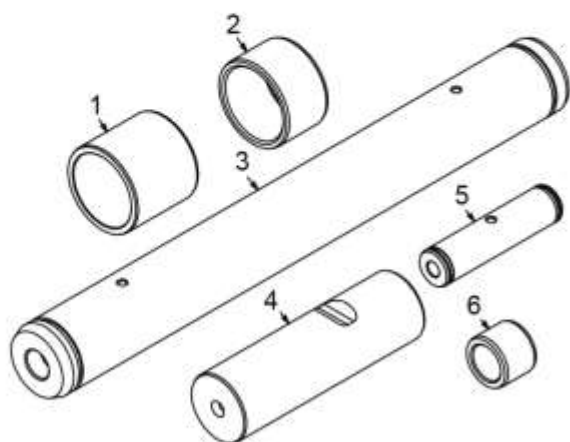

POS.	CÓDIGO
1	D138047
2	D137345
3	138616A1
4	D123865
5	D150155
6	D127507

KIT - 580M EIXO DIANTEIRO 4X4 (KT 580M E 4X4)

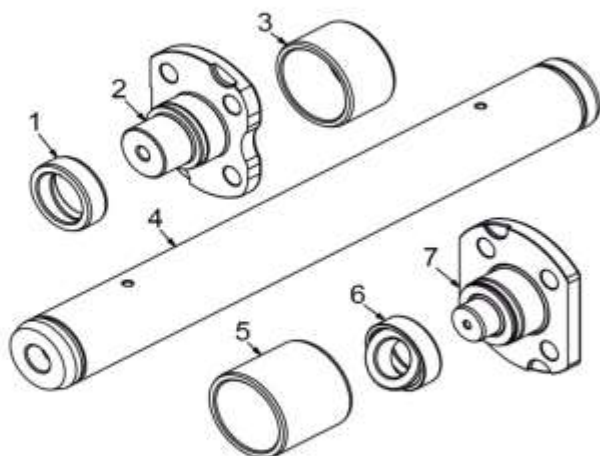

POS.	CÓDIGO
1	100522A1
2	122265A1
3	D149726
4	138616A1
5	D149725
6	100520A1
7	122264A1

KIT - 580M DIANTEIRO 4X2

(KT 580M D)

POS.	CÓDIGO
1	D127542
2	D151034
3	D50146
4	109268A1
5	118901A1
6	D132076
7	G108512
8	D145767
9	118900A1
10	113629A1
11	D129264
12	116339A1
13	100696A1

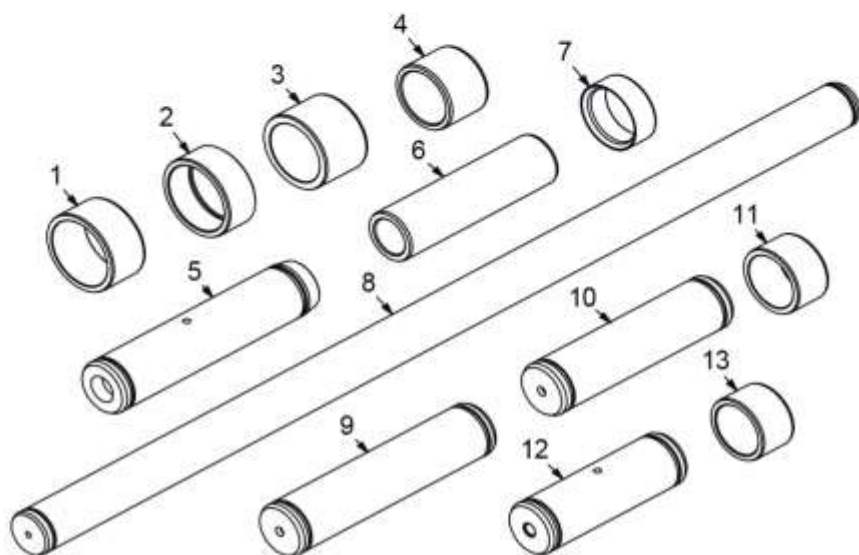

KIT - 580M TRASEIRO (KT 580M T)

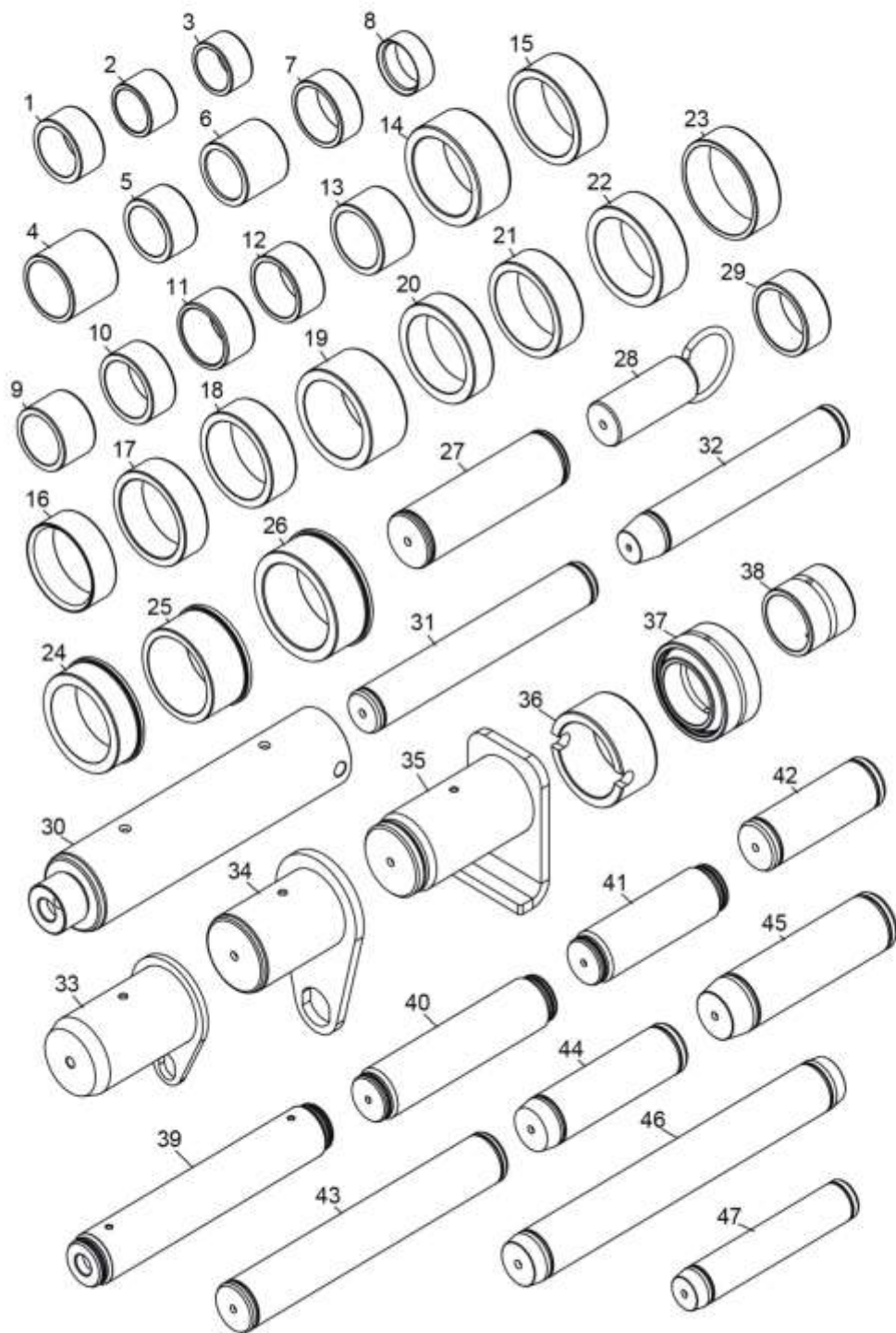

POS.	CÓDIGO
1	107124A1
2	D30933
3	D31140
4	D138047
5	D37495
6	75260976
7	D140029
8	G108512
9	D50146
10	135249A1
11	D149079
12	D145978
13	135248A1
14	D151070
15	D151073
16	124568A2
17	D151074
18	D135557
19	D137218
20	D135741
21	D135559
22	D151069
23	114318A1
24	121778A1
25	75261187
26	D151071
27	142842A1
28	D149239
29	75261188
30	D132494
31	D28648
32	D37614
33	148694A1
34	121779A1
35	148687A1
36	D135739
37	137248A1
38	180427A1
39	D141142
40	129040A1
41	129041A1
42	D38907
43	121665A1
44	D146288
45	135247A1
46	D150619
47	148346A1

KIT - 580M DIANTEIRO 4X4

(KT 580M D 4X4)

POS.	CÓDIGO
1	100696A1
2	D129264
3	109268A1
4	D127542
5	D151034
6	180427A1
7	D145767
8	119129A1
9	118900A1
10	113629A1
11	118901A1
12	116339A1
13	D132076

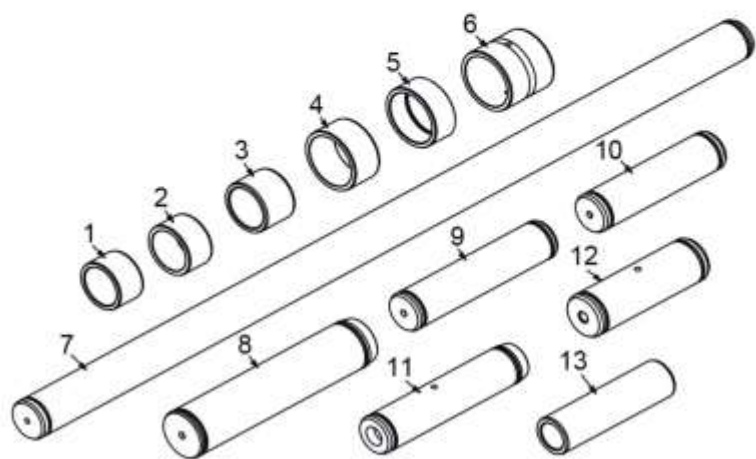

KIT - 580N DIANTEIRO

(KT 580N D)

POS.	CÓDIGO
1	84270815
2	84217542
3	D151034
4	109268A1
5	D129264
6	100696A1
7	D127542
8	84367828
9	84216893
10	104824A1
11	84216892
12	335177A1

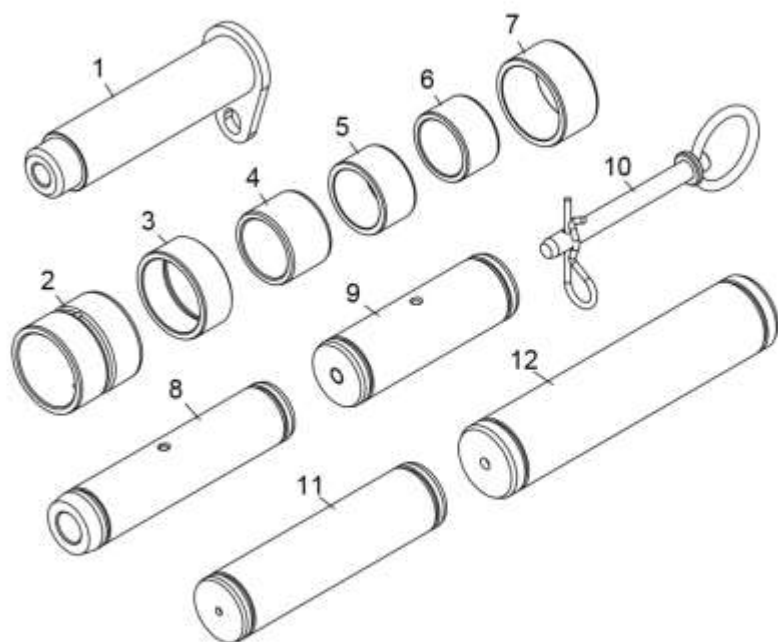

KIT - 580N TRASEIRO (KT 580N T)

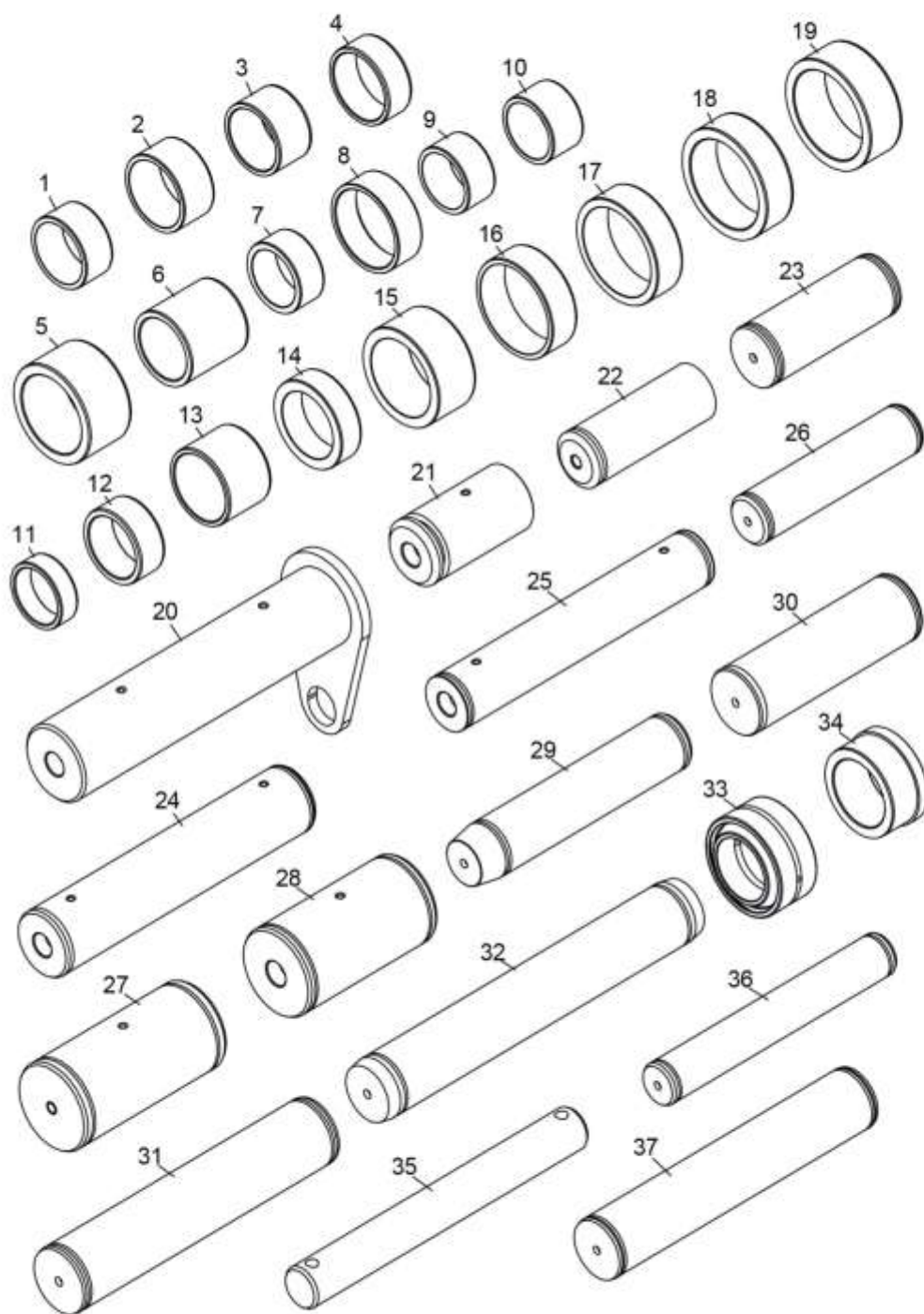

POS.	CÓDIGO
1	84244076
2	84230813
3	84229922
4	123407A1
5	84240578
6	84247142
7	135249A1
8	124568A2
9	84244078
10	84170645
11	84231079
12	84326305
13	84231081
14	84326988
15	D137218
16	114318A1
17	84235607
18	84226809
19	84226810
20	84520512
21	84248744
22	84261887
23	84243667
24	84171217
25	84171343
26	84243668
27	84249275
28	84249274
29	84223653
30	84217317
31	84248656
32	84223654
33	137248A1
34	84246051
35	D149033
36	D28648
37	84243665

KIT - 580N CAÇAMBA (KT 580N CAÇAMBA)

POS.	CÓDIGO
1	84244076
2	84244078
3	84170645
4	84231079
5	84223653
6	84231081
7	84171343
8	84230813
9	84223654
10	84247142
11	84171217

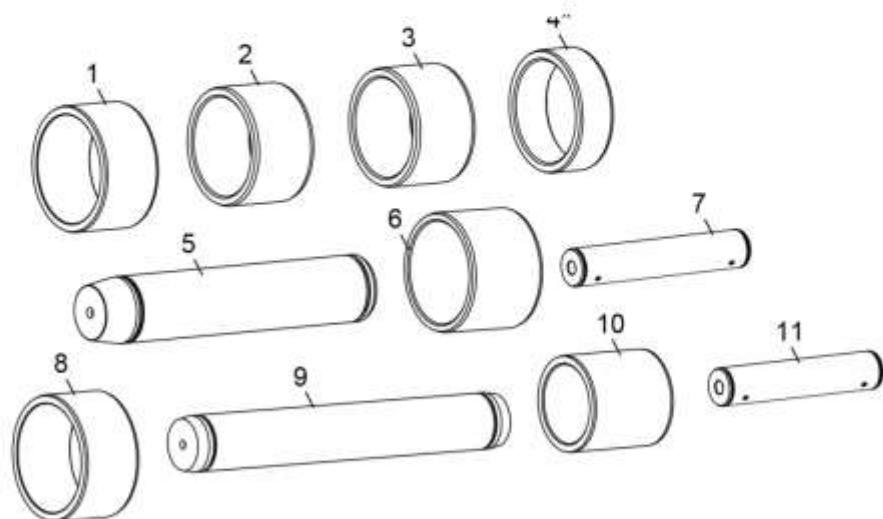

KIT - 580N ESTABILIZADOR (KT 580N ESTABILIZADOR)

POS.	CÓDIGO
1	84243667
2	84243665
3	84229922
4	84243668
5	D28648
6	84326305

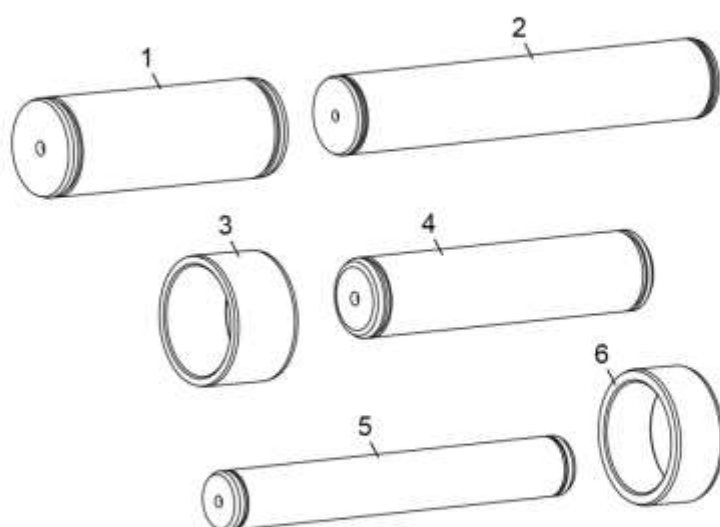

KIT - 580N GIRO (KT 580 GIRO)

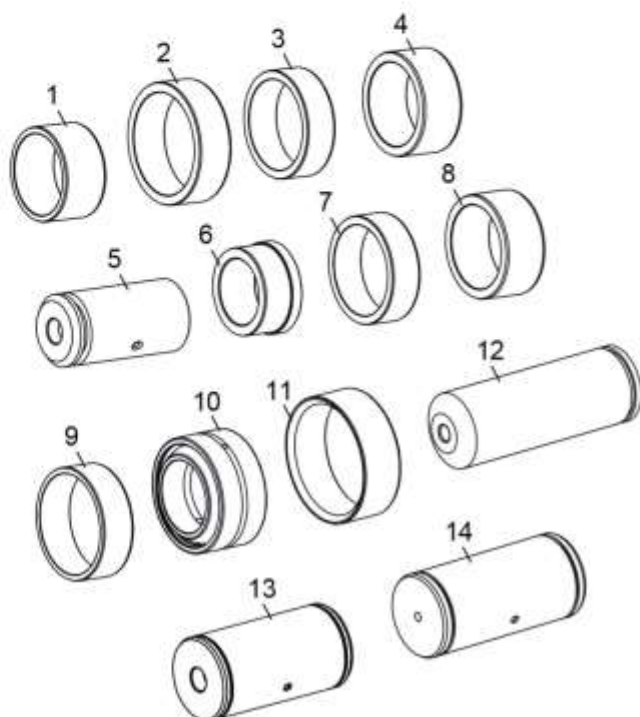

POS.	CÓDIGO
1	84230813
2	84235607
3	84326988
4	135249A1
5	84248744
6	84246051
7	84226809
8	84226810
9	114318A1
10	137248A1
11	124568A2
12	84261887
13	84249274
14	84249275

KIT - 580N LANÇA (KT 580N LANÇA)

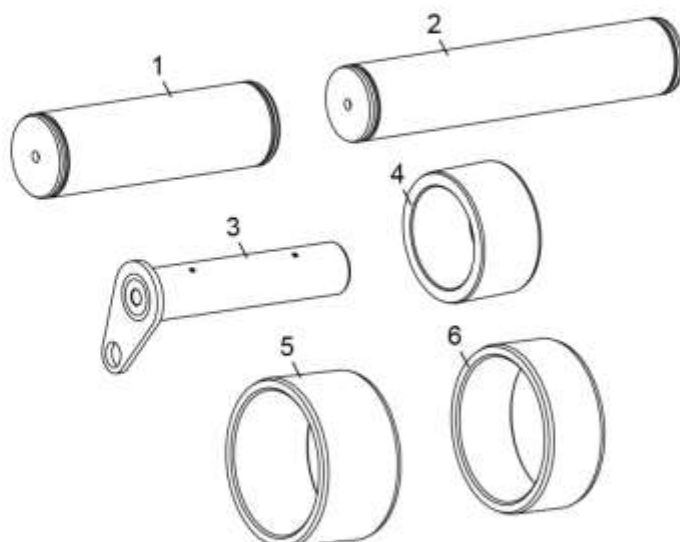

POS.	CÓDIGO
1	84217317
2	84248656
3	84520512
4	84240578
5	1346101C1
6	123407A1

KIT - W20 ANTIGO (KT W20 ANTIGO)

POS.	CÓDIGO
1	L47306
2	L47305
3	D33024
4	D38943
5	D33023
6	D44543
7	L15802
8	L47560
9	L47565
10	L15725
11	L40421
12	L47562
13	L15800

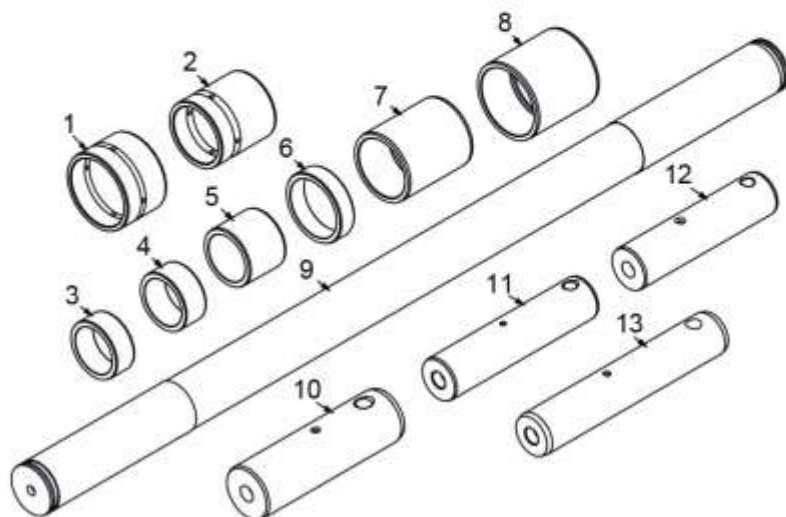

KIT - W20 MODERNO (KT W20 MODERNO)

POS.	CÓDIGO
1	L117466
2	L17466
3	L72998
4	E158734
5	E158752
6	D44543
7	L117465
8	L47565
9	E96436
10	L47564
11	E159037
12	E159035
13	E159038
14	E159036
15	L105214
16	E159033

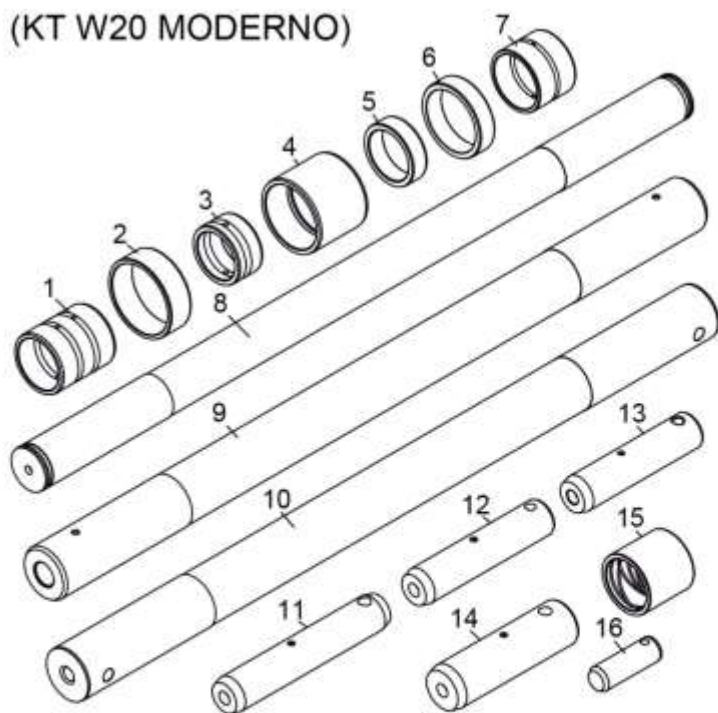

KIT - W20 B (KT W20 B)

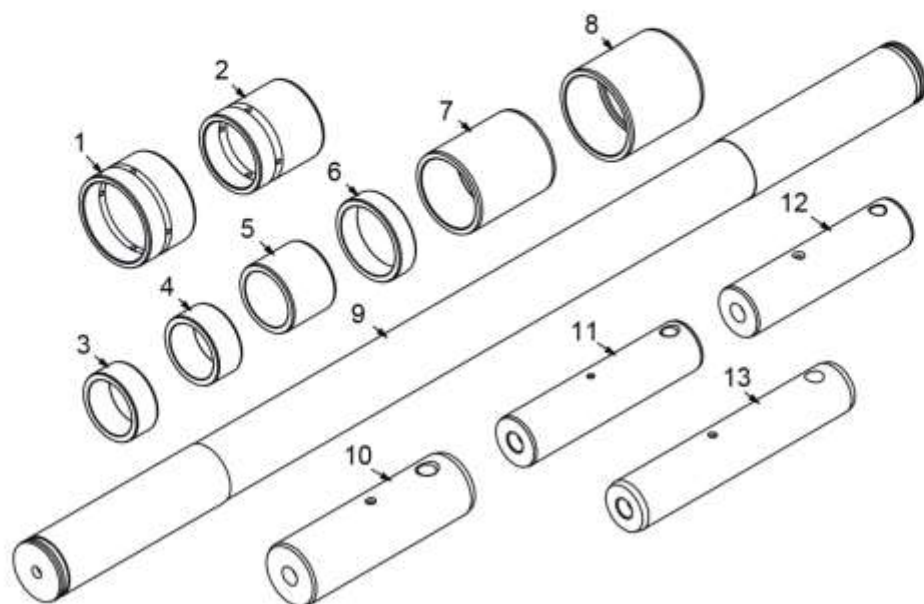





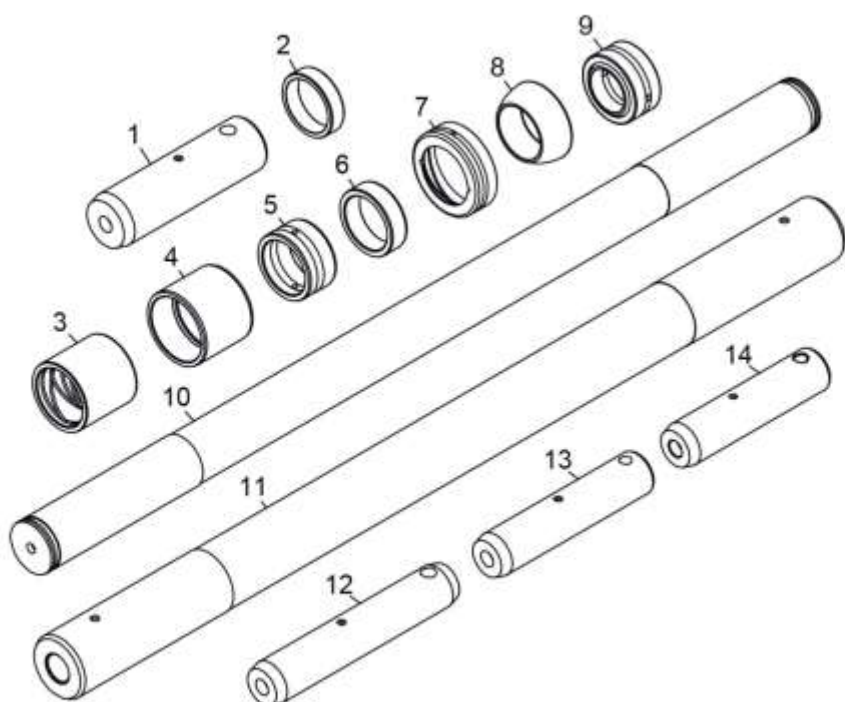







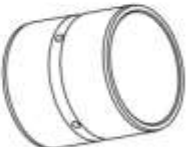

























POS.	CÓDIGO
1	L47306
2	L47305
3	D33024
4	D38943
5	D33023
6	D44543
7	L15802
8	L47560
9	L47565
10	L15725
11	L47562
12	L40421
13	L15800





















KIT - W20 E (KT W20 E)











































POS.	CÓDIGO
1	E159036
2	D44543
3	L105214
4	E158734
5	L72998
6	E158752
7	L17463
8	L17462
9	L12570
10	L47565
11	E96436
12	E159037
13	E159035
14	E159038





















<p>BUCHA</p>  <p>123475</p>	<p>BUCHA</p>  <p>708535</p>	<p>BUCHA</p>  <p>708570</p>	<p>BUCHA</p>  <p>708585</p>
<p>BUCHA</p>  <p>809090</p>	<p>BUCHA</p>  <p>809535</p>	<p>BUCHA</p>  <p>809560</p>	<p>BUCHA</p>  <p>809585</p>
<p>BUCHA</p>  <p>809590</p>	<p>BUCHA</p>  <p>809595</p>	<p>BUCHA</p>  <p>930363</p>	<p>BUCHA</p>  <p>0990718</p>
<p>BUCHA</p>  <p>0990721</p>	<p>BUCHA</p>  <p>1024560</p>	<p>BUCHA</p>  <p>1181008</p>	<p>BUCHA</p>  <p>1195200</p>
<p>BUCHA</p>  <p>1195214</p>	<p>BUCHA</p>  <p>1195228</p>	<p>BUCHA</p>  <p>1195229</p>	<p>BUCHA</p>  <p>1289863</p>















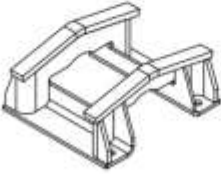

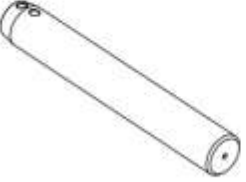
<p>BUCHA</p>  <p>1289882</p>	<p>BUCHA</p>  <p>1297770</p>	<p>BUCHA</p>  <p>1372919</p>	<p>BUCHA</p>  <p>1373060</p>
<p>BUCHA</p>  <p>1433841</p>	<p>BUCHA</p>  <p>1450804</p>	<p>BUCHA</p>  <p>1461842</p>	<p>BUCHA</p>  <p>1461843</p>
<p>BUCHA</p>  <p>1545257</p>	<p>BUCHA</p>  <p>1573309</p>	<p>BUCHA</p>  <p>1633749</p>	<p>BUCHA</p>  <p>1633751</p>
<p>BUCHA</p>  <p>1680480</p>	<p>BUCHA</p>  <p>1713667</p>	<p>BUCHA</p>  <p>1935015</p>	<p>BUCHA</p>  <p>2037322</p>
<p>BUCHA</p>  <p>2096181</p>	<p>BUCHA</p>  <p>2099887</p>	<p>BUCHA</p>  <p>2136687</p>	<p>BUCHA</p>  <p>2136702</p>

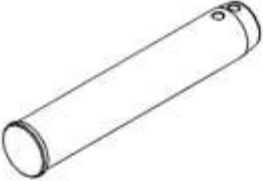
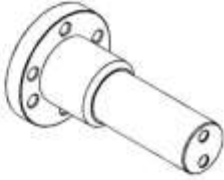
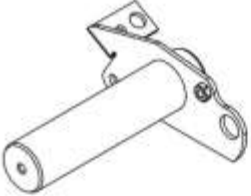

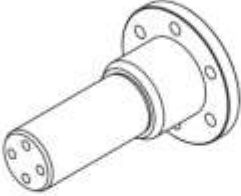





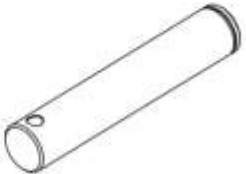

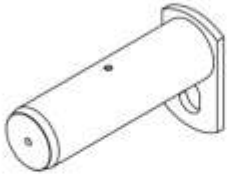

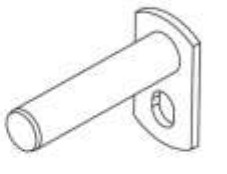
<p>BUCHA</p>  <p>2136703</p>	<p>BUCHA</p>  <p>2213197</p>	<p>BUCHA</p>  <p>2366268</p>	<p>BUCHA</p>  <p>2368183</p>
<p>BUCHA</p>  <p>2370945</p>	<p>BUCHA</p>  <p>2417381</p>	<p>BUCHA</p>  <p>03225020</p>	<p>BUCHA</p>  <p>3336676</p>
<p>BUCHA</p>  <p>8292010</p>	<p>BUCHA</p>  <p>2G7387</p>	<p>BUCHA</p>  <p>4I0453</p>	<p>BUCHA</p>  <p>4I5216</p>
<p>BUCHA</p>  <p>6J2242</p>	<p>BUCHA</p>  <p>7J9682</p>	<p>BUCHA</p>  <p>7J9699</p>	<p>BUCHA</p>  <p>7J9842</p>
<p>BUCHA</p>  <p>9J5284</p>	<p>BUCHA</p>  <p>4K6780</p>	<p>BUCHA</p>  <p>6K4076</p>	<p>BUCHA</p>  <p>7K0088</p>



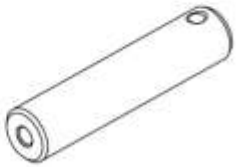
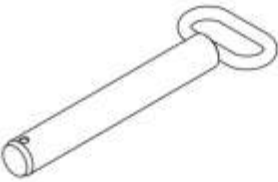
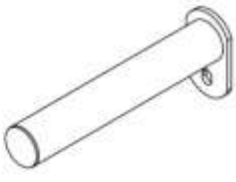
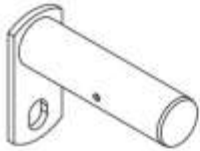

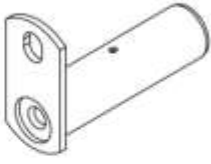
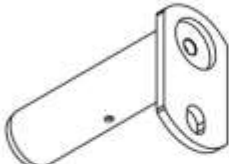

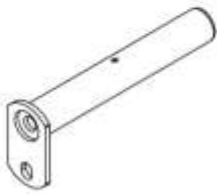





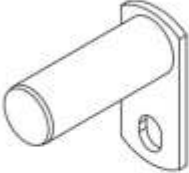
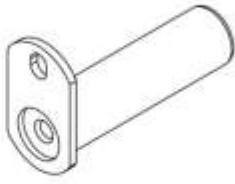

<p>BUCHA</p>  <p>7K9589</p>	<p>BUCHA</p>  <p>7K9601</p>	<p>BUCHA</p>  <p>7K9602</p>	<p>BUCHA</p>  <p>7K9603</p>
<p>BUCHA</p>  <p>7K9604</p>	<p>BUCHA</p>  <p>7K9638</p>	<p>BUCHA</p>  <p>7K9639</p>	<p>BUCHA</p>  <p>7K9640</p>
<p>BUCHA</p>  <p>7K9642</p>	<p>BUCHA</p>  <p>7K9643</p>	<p>BUCHA</p>  <p>9K9158</p>	<p>BUCHA</p>  <p>9K9731</p>
<p>BUCHA</p>  <p>7P6596</p>	<p>BUCHA</p>  <p>9R0111</p>	<p>BUCHA</p>  <p>9R0139</p>	<p>BUCHA</p>  <p>9R0140</p>
<p>BUCHA</p>  <p>9R0147</p>	<p>BUCHA</p>  <p>9R0153</p>	<p>BUCHA</p>  <p>9R0170</p>	<p>BUCHA</p>  <p>9R0320</p>



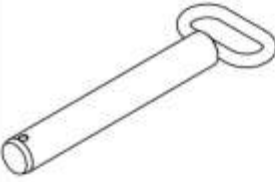
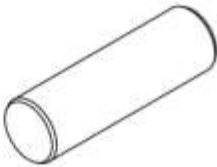

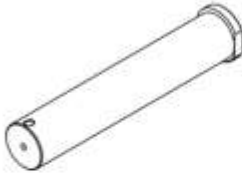

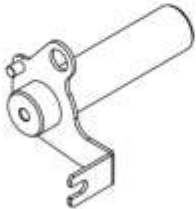
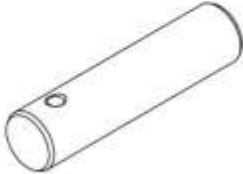
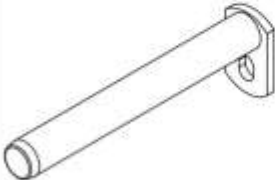



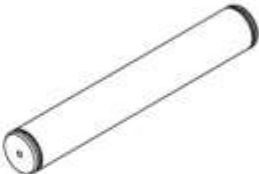
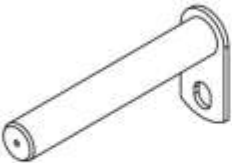





<p>BUCHA</p>  <p>9R0321</p>	<p>BUCHA</p>  <p>9R0411</p>	<p>BUCHA</p>  <p>9R0413</p>	<p>BUCHA</p>  <p>9R0430</p>
<p>BUCHA</p>  <p>9R0431</p>	<p>BUCHA</p>  <p>9R1104</p>	<p>BUCHA</p>  <p>9R1107</p>	<p>BUCHA</p>  <p>9R1917</p>
<p>BUCHA</p>  <p>9R2700</p>	<p>BUCHA</p>  <p>9R3092</p>	<p>BUCHA</p>  <p>9R3639</p>	<p>BUCHA</p>  <p>9R3723</p>
<p>BUCHA</p>  <p>9R4110</p>	<p>BUCHA</p>  <p>9R4675</p>	<p>BUCHA</p>  <p>9R5246</p>	<p>BUCHA</p>  <p>9R5828</p>
<p>BUCHA</p>  <p>9R6690</p>	<p>BUCHA</p>  <p>9R7703</p>	<p>BUCHA</p>  <p>9R7891</p>	<p>BUCHA</p>  <p>9R7960</p>

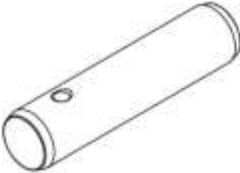

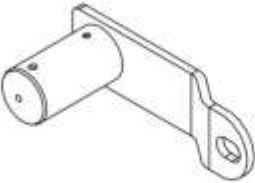

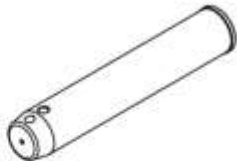
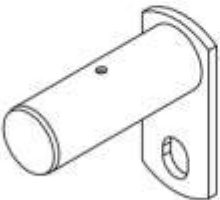





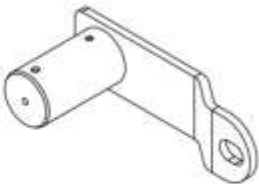

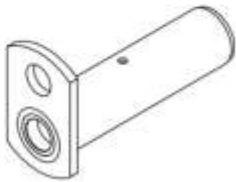
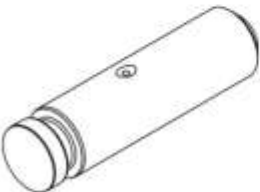
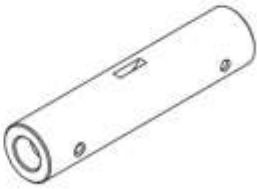

<p>BUCHA</p>  <p>9R9475</p>	<p>BUCHA</p>  <p>9R9505</p>	<p>BUCHA</p>  <p>9T0766</p>	<p>BUCHA</p>  <p>9T2883</p>
<p>BUCHA</p>  <p>9T4007</p>	<p>BUCHA</p>  <p>9T5599</p>	<p>BUCHA</p>  <p>1V1292</p>	<p>BUCHA</p>  <p>4V0380</p>
<p>BUCHA</p>  <p>4V2883</p>	<p>BUCHA</p>  <p>4V4453</p>	<p>BUCHA</p>  <p>4V8639</p>	<p>BUCHA</p>  <p>4V8643</p>
<p>BUCHA</p>  <p>9V3404</p>	<p>BUCHA</p>  <p>9V3405</p>	<p>BUCHA</p>  <p>9V3406</p>	<p>BUCHA</p>  <p>9V4973</p>
<p>BUCHA</p>  <p>9V4975</p>	<p>BUCHA</p>  <p>7Y2395</p>	<p>BUCHA</p>  <p>7Y2396</p>	<p>BUCHA</p>  <p>7Y2397</p>

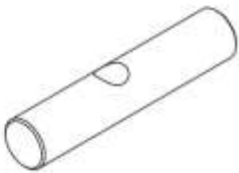
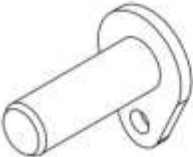

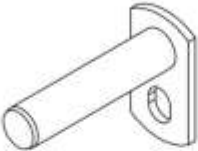

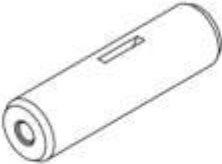
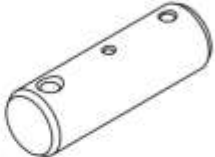
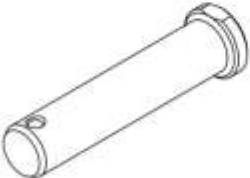
<p>BUCHA</p>  <p>7Y3427</p>	<p>BUCHA</p>  <p>7Y3428</p>	<p>BUCHA</p>  <p>7Y5128</p>	<p>SUPORTE</p>  <p>1175553</p>
<p>SUPORTE</p>  <p>2402988</p>	<p>PINO</p>  <p>0860523</p>	<p>PINO</p>  <p>0875805</p>	<p>PINO</p>  <p>0875806</p>
<p>PINO</p>  <p>0875845</p>	<p>PINO</p>  <p>1003852</p>	<p>PINO</p>  <p>1014020</p>	<p>PINO</p>  <p>1014022</p>
<p>PINO</p>  <p>1133791</p>	<p>PINO</p>  <p>1285010</p>	<p>PINO</p>  <p>1285070</p>	<p>PINO</p>  <p>1300479</p>
<p>PINO</p>  <p>1300484</p>	<p>PINO</p>  <p>1300485</p>	<p>PINO</p>  <p>1301638</p>	<p>PINO</p>  <p>1305451</p>

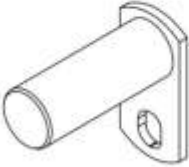



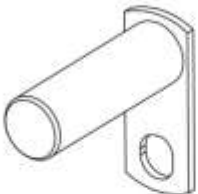
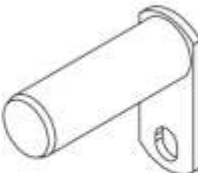
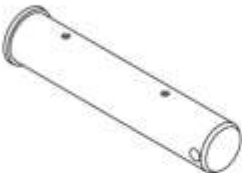
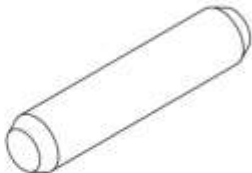
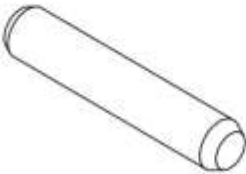

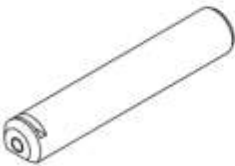

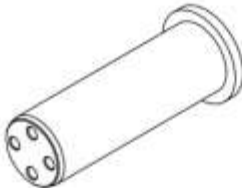
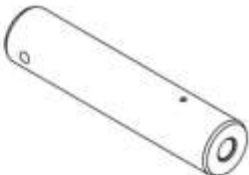
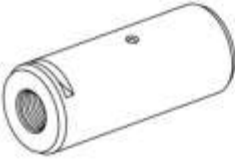
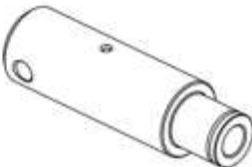
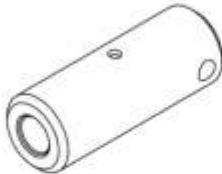
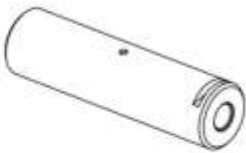
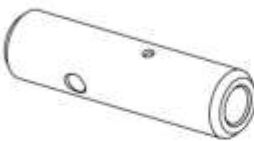
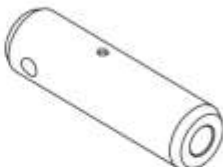
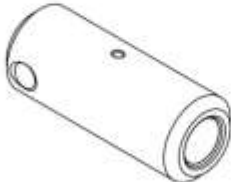
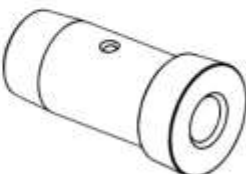
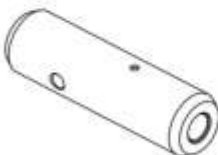
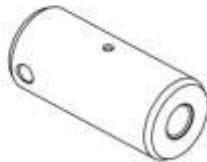

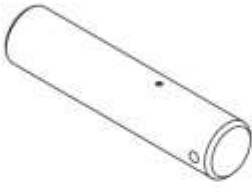

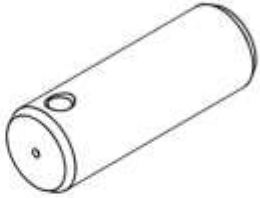
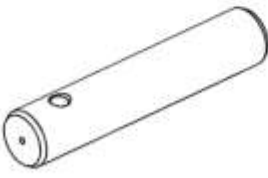
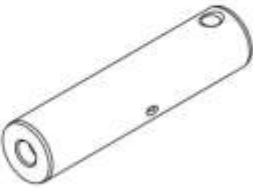
<p>PINO</p>  <p>1322419</p>	<p>PINO</p>  <p>1322427</p>	<p>PINO</p>  <p>1322553</p>	<p>PINO</p>  <p>1322554</p>
<p>PINO</p>  <p>1323777</p>	<p>PINO</p>  <p>1326496</p>	<p>PINO</p>  <p>1428790</p>	<p>PINO</p>  <p>1428793</p>
<p>PINO</p>  <p>1458348</p>	<p>PINO</p>  <p>1467990</p>	<p>PINO</p>  <p>1467993</p>	<p>PINO</p>  <p>1467996</p>
<p>PINO</p>  <p>1468000</p>	<p>PINO</p>  <p>1468003</p>	<p>PINO</p>  <p>1468006</p>	<p>PINO</p>  <p>1468009</p>
<p>PINO</p>  <p>1468010</p>	<p>PINO</p>  <p>1468013</p>	<p>PINO</p>  <p>1468016</p>	<p>PINO</p>  <p>1468019</p>

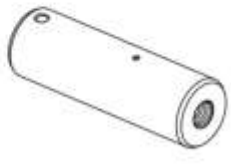
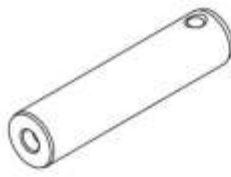
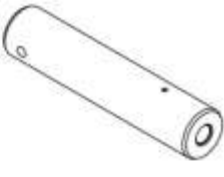
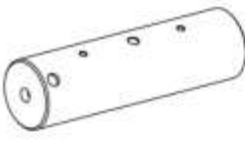
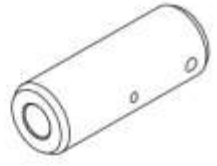
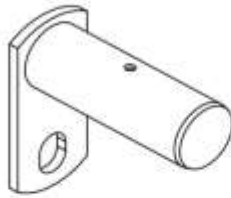

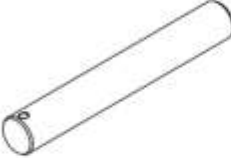

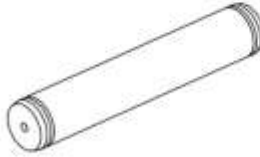









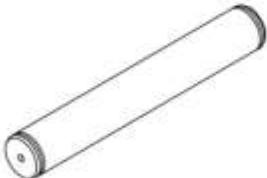

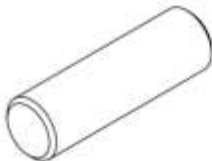

<p>PINO</p>  <p>1487870</p>	<p>PINO</p>  <p>1487871</p>	<p>PINO</p>  <p>1487873</p>	<p>PINO</p>  <p>1487874</p>
<p>PINO</p>  <p>1487875</p>	<p>PINO</p>  <p>1487876</p>	<p>PINO</p>  <p>1487877</p>	<p>PINO</p>  <p>1590960</p>
<p>PINO</p>  <p>1680425</p>	<p>PINO</p>  <p>1680443</p>	<p>PINO</p>  <p>1680475</p>	<p>PINO</p>  <p>1732769</p>
<p>PINO</p>  <p>1732796</p>	<p>PINO</p>  <p>1745696</p>	<p>PINO</p>  <p>1883066</p>	<p>PINO</p>  <p>1919588</p>
<p>PINO</p>  <p>2096850</p>	<p>PINO</p>  <p>2096855</p>	<p>PINO</p>  <p>2119286</p>	<p>PINO</p>  <p>2136696</p>



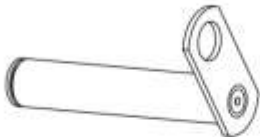
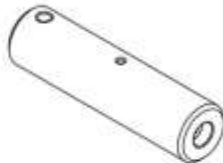







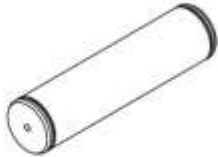

<p>PINO</p>  <p>2136697</p>	<p>PINO</p>  <p>2136698</p>	<p>PINO</p>  <p>2136710</p>	<p>PINO</p>  <p>2136714</p>
<p>PINO</p>  <p>2136726</p>	<p>PINO</p>  <p>2146143</p>	<p>PINO</p>  <p>2201018</p>	<p>PINO</p>  <p>2201019</p>
<p>PINO</p>  <p>2357636</p>	<p>PINO</p>  <p>2357642</p>	<p>PINO</p>  <p>2368182</p>	<p>PINO</p>  <p>2375330</p>
<p>PINO</p>  <p>2477631</p>	<p>PINO</p>  <p>2487820</p>	<p>PINO</p>  <p>2543052</p>	<p>PINO</p>  <p>2543053</p>
<p>PINO</p>  <p>2571636</p>	<p>PINO</p>  <p>2908156</p>	<p>PINO</p>  <p>2937383</p>	<p>PINO</p>  <p>3005440</p>



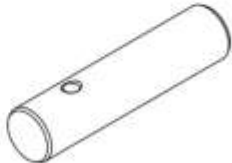
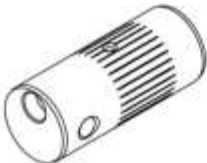
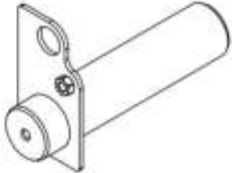
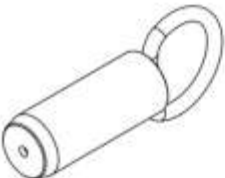

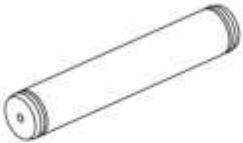

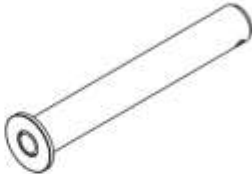

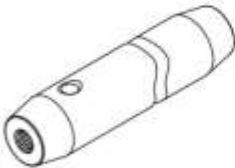
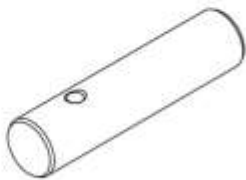
<p>PINO</p>  <p>3005442</p>	<p>PINO</p>  <p>3288776</p>	<p>PINO</p>  <p>3305854</p>	<p>PINO</p>  <p>3933685</p>
<p>PINO</p>  <p>7B2503</p>	<p>PINO</p>  <p>9C3851</p>	<p>PINO</p>  <p>9C8862</p>	<p>PINO</p>  <p>2D4209</p>
<p>PINO</p>  <p>2D5961</p>	<p>PINO</p>  <p>5D7462</p>	<p>PINO</p>  <p>8D2429</p>	<p>PINO</p>  <p>8D4766</p>
<p>PINO</p>  <p>4E4524</p>	<p>PINO</p>  <p>2G8609</p>	<p>PINO</p>  <p>2G8613</p>	<p>PINO</p>  <p>9G5525</p>
<p>PINO</p>  <p>3H8272</p>	<p>PINO</p>  <p>4I4808</p>	<p>PINO</p>  <p>4I4809</p>	<p>PINO</p>  <p>4I4813</p>

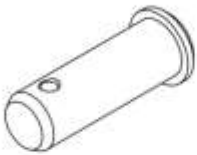
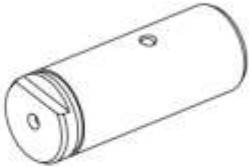

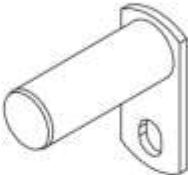
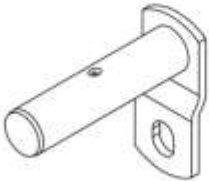
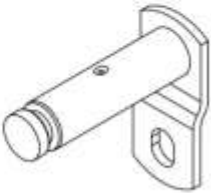
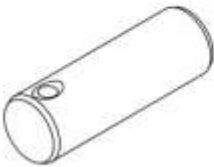

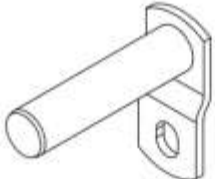
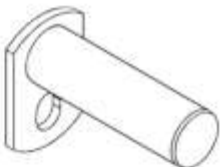
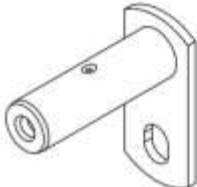

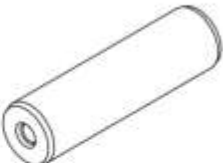
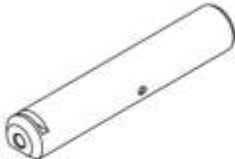

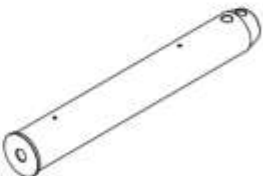
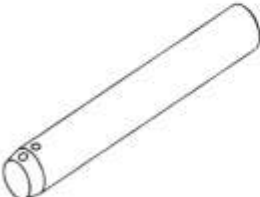
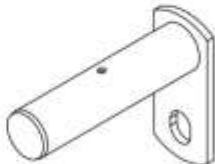
<p>PINO</p>  <p>414814</p>	<p>PINO</p>  <p>513291</p>	<p>PINO</p>  <p>716843</p>	<p>PINO</p>  <p>8J4258</p>
<p>PINO</p>  <p>9J2258</p>	<p>PINO</p>  <p>4K8225</p>	<p>PINO</p>  <p>5K3042</p>	<p>PINO</p>  <p>5K8265</p>
<p>PINO</p>  <p>6K4192</p>	<p>PINO</p>  <p>6K5334</p>	<p>PINO</p>  <p>6K6045</p>	<p>PINO</p>  <p>6K6046</p>
<p>PINO</p>  <p>6K6047</p>	<p>PINO</p>  <p>6K6051</p>	<p>PINO</p>  <p>6K6053</p>	<p>PINO</p>  <p>6K6054</p>
<p>PINO</p>  <p>6K6175</p>	<p>PINO</p>  <p>6K6185</p>	<p>PINO</p>  <p>6K8307</p>	<p>PINO</p>  <p>6K8308</p>

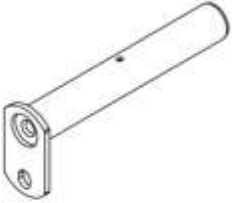
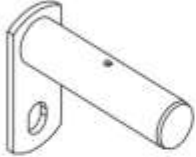

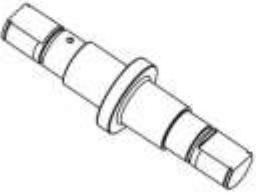

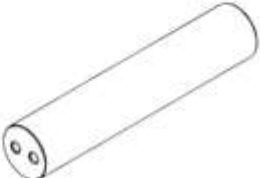
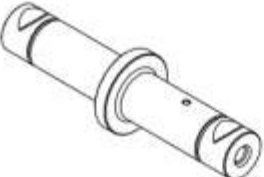

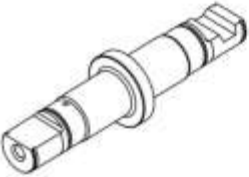
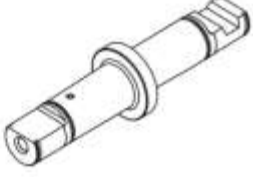
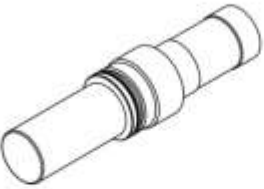
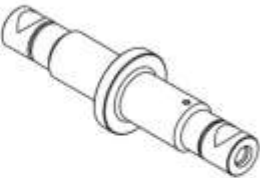
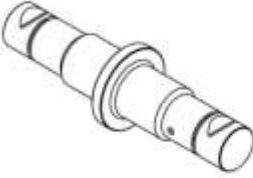
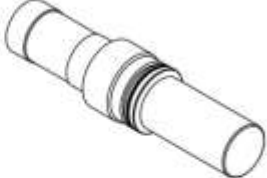
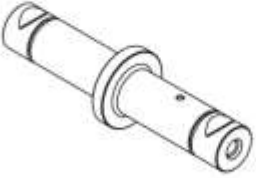

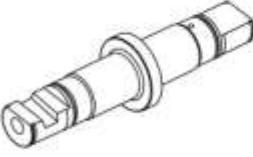
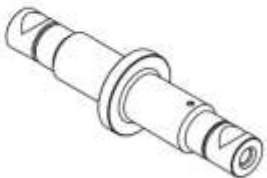

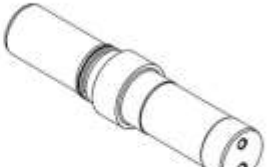
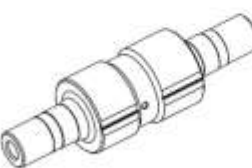
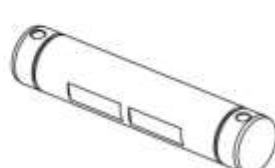
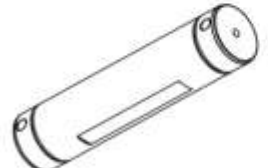

<p>PINO</p>  <p>6K8309</p>	<p>PINO</p>  <p>6k8310</p>	<p>PINO</p>  <p>7K7176</p>	<p>PINO</p>  <p>7K7200</p>
<p>PINO</p>  <p>7K9343</p>	<p>PINO</p>  <p>7K9345</p>	<p>PINO</p>  <p>7K9513</p>	<p>PINO</p>  <p>7K9514</p>
<p>PINO</p>  <p>7K9515</p>	<p>PINO</p>  <p>8K5334</p>	<p>PINO</p>  <p>5M6211</p>	<p>PINO</p>  <p>6P3733</p>
<p>PINO</p>  <p>7P1577</p>	<p>PINO</p>  <p>9P7752</p>	<p>PINO</p>  <p>8Q4294</p>	<p>PINO</p>  <p>9R0097</p>
<p>PINO</p>  <p>9R0110</p>	<p>PINO</p>  <p>9R0159</p>	<p>PINO</p>  <p>9R0160</p>	<p>PINO</p>  <p>9R0234</p>

<p>PINO</p>  <p>9R0240</p>	<p>PINO</p>  <p>9R0422</p>	<p>PINO</p>  <p>9R0423</p>	<p>PINO</p>  <p>9R0424</p>
<p>PINO</p>  <p>9R0437</p>	<p>PINO</p>  <p>9R0438</p>	<p>PINO</p>  <p>9R0472</p>	<p>PINO</p>  <p>9R1100</p>
<p>PINO</p>  <p>9R2956</p>	<p>PINO</p>  <p>9R2958</p>	<p>PINO</p>  <p>9R3182</p>	<p>PINO</p>  <p>9R3933</p>
<p>PINO</p>  <p>9R4494</p>	<p>PINO</p>  <p>9R4676</p>	<p>PINO</p>  <p>9R4677</p>	<p>PINO</p>  <p>9R6161</p>
<p>PINO</p>  <p>9R6162</p>	<p>PINO</p>  <p>9R6163</p>	<p>PINO</p>  <p>9R6784</p>	<p>PINO</p>  <p>9R7011</p>

<p>PINO</p>  <p>9R7693</p>	<p>PINO</p>  <p>9R7696</p>	<p>PINO</p>  <p>9R8202</p>	<p>PINO</p>  <p>9R8206</p>
<p>PINO</p>  <p>9R8523</p>	<p>PINO</p>  <p>9R8562</p>	<p>PINO</p>  <p>9R8577</p>	<p>PINO</p>  <p>9R8579</p>
<p>PINO</p>  <p>9R8583</p>	<p>PINO</p>  <p>9R8580</p>	<p>PINO</p>  <p>9R8594</p>	<p>PINO</p>  <p>9R8604</p>
<p>PINO</p>  <p>9R8662</p>	<p>PINO</p>  <p>9R8663</p>	<p>PINO</p>  <p>9R8664</p>	<p>PINO</p>  <p>9R9105</p>
<p>PINO</p>  <p>9R9373</p>	<p>PINO</p>  <p>9R9615</p>	<p>PINO</p>  <p>9R9631</p>	<p>PINO</p>  <p>9R9812</p>

<p>PINO</p>  <p>0S0175</p>	<p>PINO</p>  <p>2V1074</p>	<p>PINO</p>  <p>4V3625</p>	<p>PINO</p>  <p>4V9901</p>
<p>PINO</p>  <p>9V3279</p>	<p>PINO</p>  <p>9V3280</p>	<p>PINO</p>  <p>9V3285</p>	<p>PINO</p>  <p>9V3289</p>
<p>PINO</p>  <p>9V3363</p>	<p>PINO</p>  <p>9V6162</p>	<p>PINO</p>  <p>9V6503</p>	<p>PINO</p>  <p>8W5293</p>
<p>PINO</p>  <p>8W6476</p>	<p>PINO</p>  <p>8W6497</p>	<p>PINO</p>  <p>9W7080</p>	<p>PINO</p>  <p>6Y2751</p>
<p>PINO</p>  <p>7Y2348</p>	<p>PINO</p>  <p>7Y2349</p>	<p>PINO</p>  <p>7Y2357</p>	<p>PINO</p>  <p>8Y7024</p>

<p>PINO</p>  <p>8Y7028</p>	<p>PINO</p>  <p>8Y7032</p>	<p>PINO</p>  <p>8Y7033</p>	<p>PINO</p>  <p>8Y7047</p>
<p>EIXO</p>  <p>1318742</p>	<p>EIXO</p>  <p>2D4211</p>	<p>EIXO</p>  <p>8E5035</p>	<p>EIXO</p>  <p>8E5601</p>
<p>EIXO</p>  <p>8E7899</p>	<p>EIXO</p>  <p>2F8001</p>	<p>EIXO</p>  <p>7G0419</p>	<p>EIXO</p>  <p>3K6616</p>
<p>EIXO</p>  <p>3K6628</p>	<p>EIXO</p>  <p>4K9984</p>	<p>EIXO</p>  <p>5K0305</p>	<p>EIXO</p>  <p>6K9861</p>
<p>EIXO</p>  <p>9K8856</p>	<p>EIXO</p>  <p>5M1247</p>	<p>EIXO</p>  <p>5M4448</p>	<p>EIXO</p>  <p>5M5005</p>

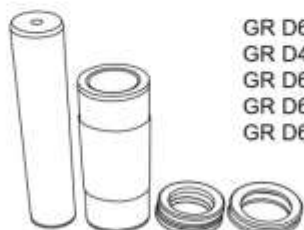
<p>EIXO</p>  <p>7M5109</p>	<p>EIXO</p>  <p>8P3128</p>	<p>EIXO</p>  <p>9S3565</p>	<p>EIXO</p>  <p>3T3207</p>
<p>EIXO</p>  <p>6T3282</p>	<p>EIXO</p>  <p>9W9451</p>	<p>EIXO</p>  <p>6Y8028</p>	<p>ENGRENAGEM</p>  <p>2087823</p>
<p>ENGRENAGEM</p>  <p>2113414</p>	<p>ESPAÇADOR</p>  <p>4K3916</p>	<p>ESPAÇADOR</p>  <p>7K2016</p>	<p>ESPAÇADOR</p>  <p>8M2621</p>
<p>ESPAÇADOR</p>  <p>8M6238</p>	<p>ESPAÇADOR</p>  <p>8M7455</p>	<p>ESPAÇADOR</p>  <p>1S4446</p>	<p>ESPAÇADOR</p>  <p>5S754</p>
<p>GRUPOS PARA ESTEIRAS</p> 			<p>GRUPOS PARA ESTEIRAS</p> 
<p>GR 312L GR D85 GR 320L GR D6A GR 330L GR D7A GR 336 GR D4C GR 955H GR D4C PFM GR 955K GR D6C GR 955L GR D4D GR 977L GR D4D PFM GR D5 GR D6D</p>			<p>GR D4E GR D4E PFM GR D7E GR D9G GR D4H BERCO GR D4H ITM GR D8H GR D6M GR D6R</p>
			<p>GR D6C CR GR D4E CR 56 GR D6D CR GR D6N CR GR D6R CR</p>

KIT - 930

(KT 930)

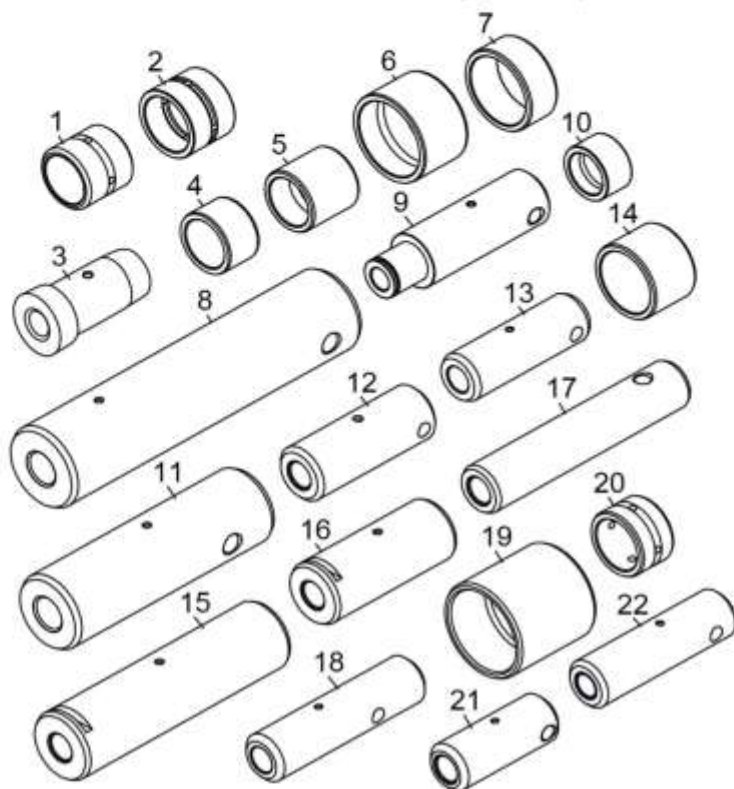

POS.	CÓDIGO
1	7K9601
2	7J9682
3	6K6185
4	7K9589
5	7K9602
6	7K9603
7	6J2242
8	7K9345
9	6K6046
10	7J9842
11	7K9344
12	6K6047
13	7K7176
14	7J9699
15	6K6051
16	6K6045
17	7K9343
18	6K6053
19	7K9604
20	7K0088
21	6K6175
22	6K6054

KIT - 966

(KT 966)

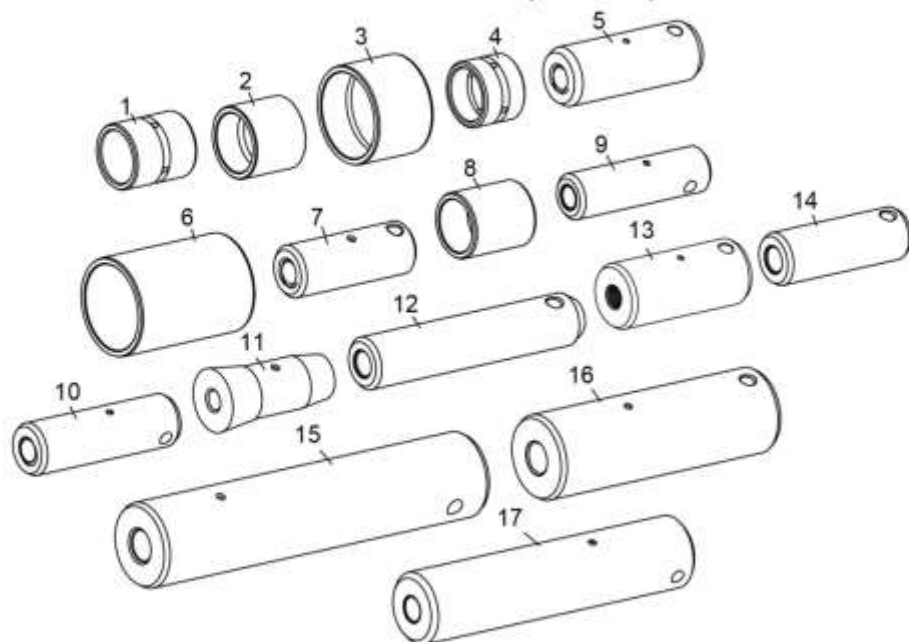

POS.	CÓDIGO
1	7K9644
2	7K9640
3	7K9643
4	7K9639
5	7K9513
6	7K9638
7	6K8308
8	7K9642
9	6K8307
10	5K8265
11	4K8225
12	7K9515
13	6K8310
14	7K7200
15	6K5334
16	7K9514
17	6K8309

KIT - 416D DIANTEIRO

(KT 416D D)

POS.	CÓDIGO
1	9R0111
2	9R0153
3	9R0321
4	9R0320
5	9R6690
6	9R1104
7	9R1107
8	9T0766
9	9R4494
10	9R3182
11	9R9373
12	9R5828
13	1326496
14	1305451

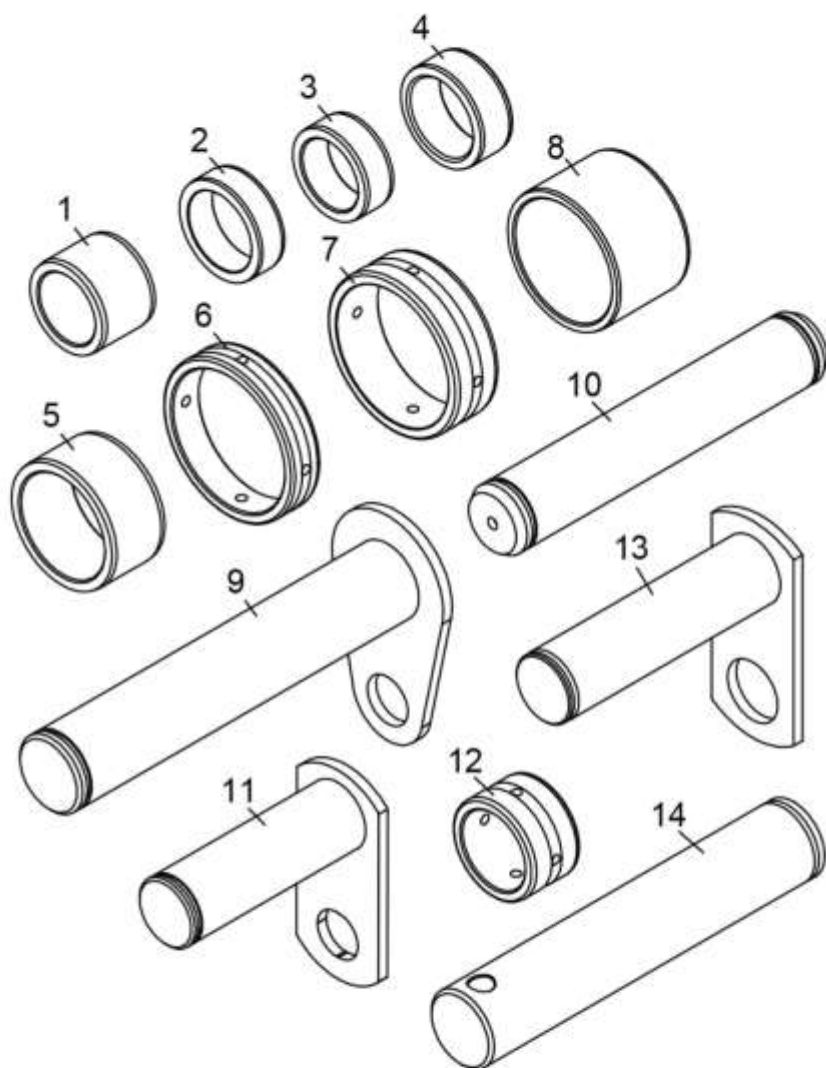

KIT - 416D TRASEIRO (KT 416D T)

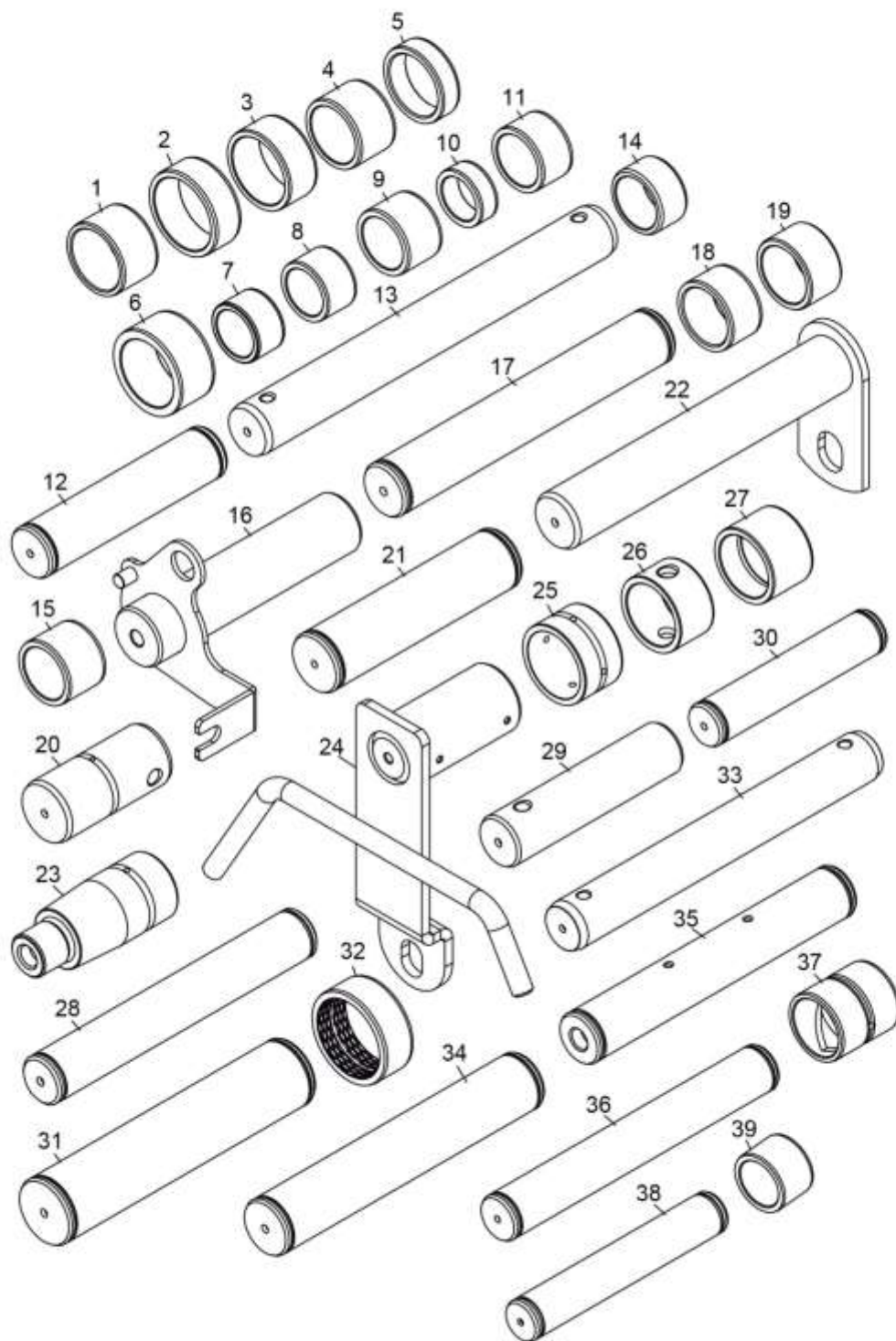

POS.	CÓDIGO
1	9R0413
2	9R4110
3	2142255
4	9R0170
5	2785454
6	2787695
7	9R0411
8	1680480
9	2136702
10	9R0321
11	9R3092
12	2136714
13	1545280
14	2136687
15	9R0162
16	2096850
17	1545278
18	9R0139
19	9R2700
20	2375330
21	2136696
22	2136710
23	3005440
24	2908156
25	2143855
26	2370944
27	2096181
28	9R0424
29	2096855
30	2616703
31	2136726
32	2627043
33	1545279
34	2136698
35	2136697
36	2389546
37	2744274
38	1301638
39	2136703

KIT - 416E DIANTEIRO

(KT 416E D)



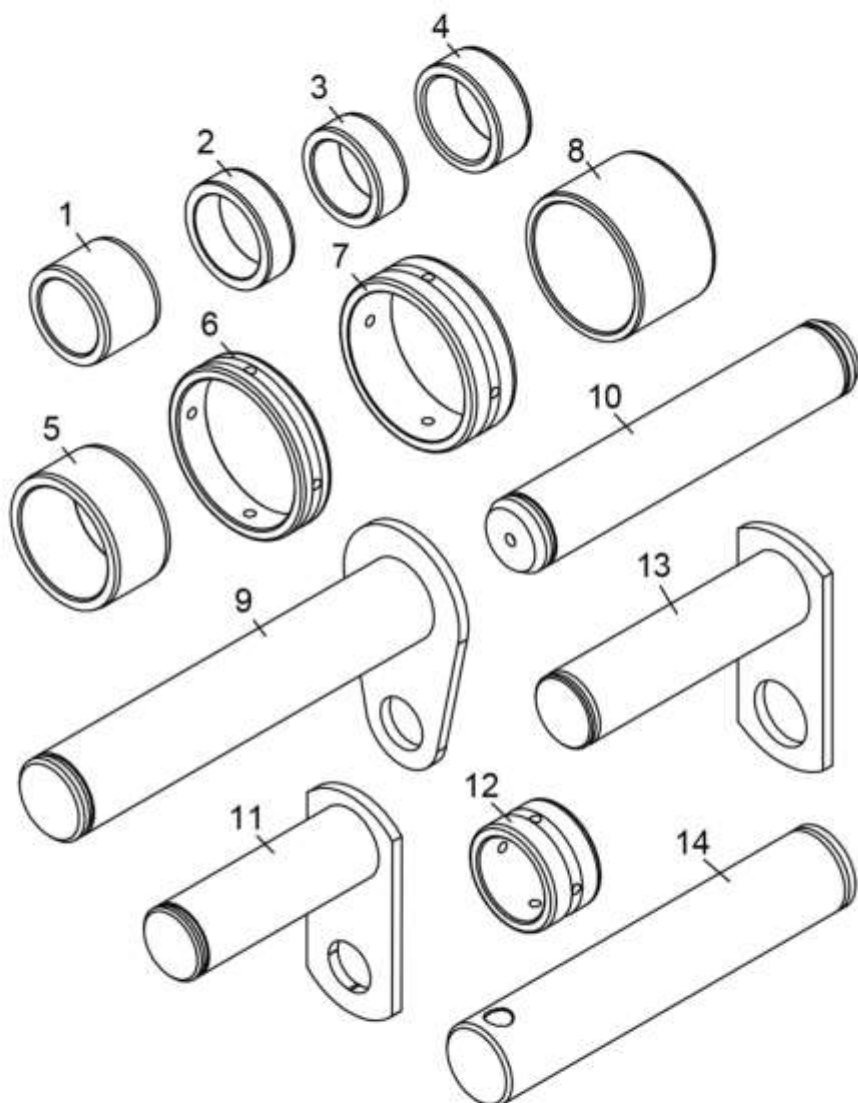



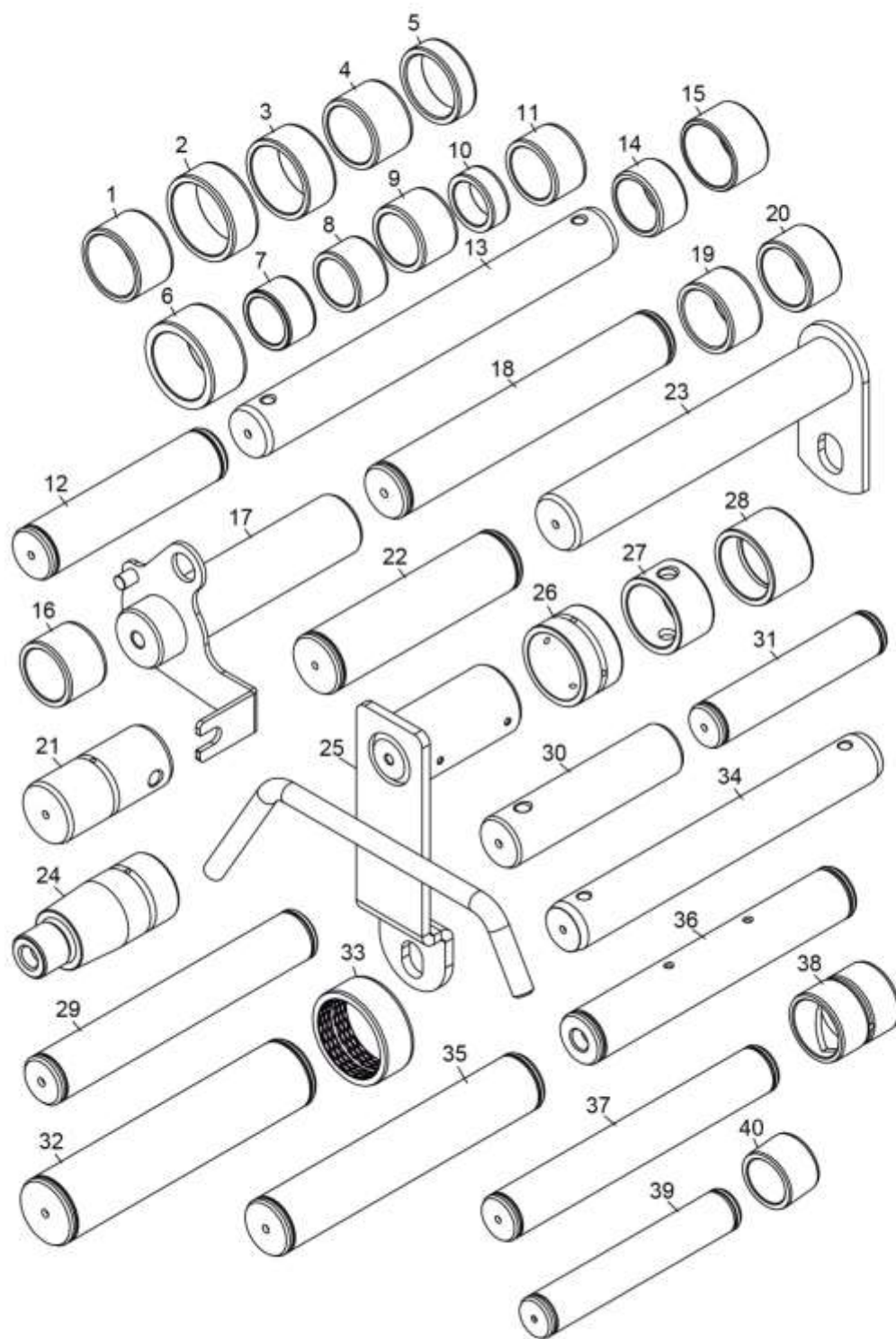

POS.	CÓDIGO
1	9R0111
2	9R0321
3	9R0153
4	9R0320
5	9R6690
6	9R1104
7	9R1107
8	9T0766
9	9R4494
10	9R3182
11	9R9373
12	9R5828
13	1326496
14	1305451





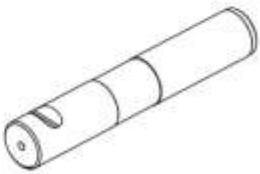
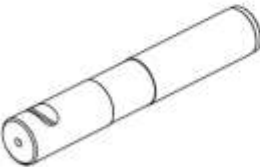





KIT - 416E TRASEIRO (KT 416E T)

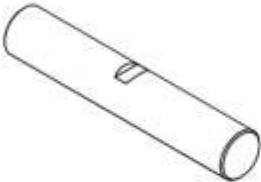
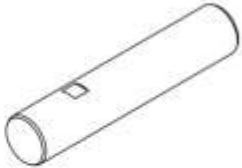
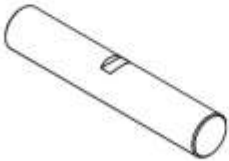
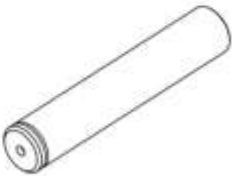

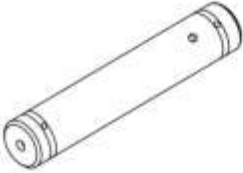
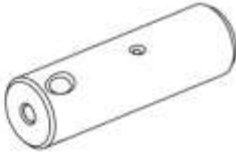

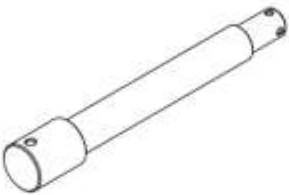
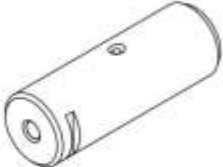
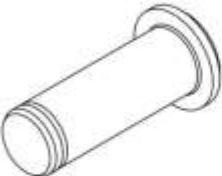
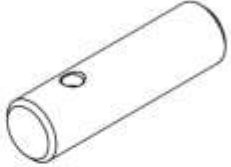





































POS.	CÓDIGO
1	9R0413
2	9R4110
3	2142255
4	9R0170
5	2785454
6	2787695
7	9R0411
8	1680480
9	2136702
10	9R0321
11	9R3092
12	2136714
13	1545280
14	2136687
15	9T2883
16	9R0162
17	2096850
18	1545278
19	9R0139
20	9R2700
21	2375330
22	2136696
23	2136710
24	3005440
25	2908156
26	2143855
27	2370944
28	2096181
29	9R0424
30	2096855
31	2616703
32	2136726
33	2627043
34	1545279
35	2136698
36	2136697
37	2389546
38	2744274
39	1301638
40	2136703









<p>PINO</p>  <p>0610204006</p>	<p>PINO</p>  <p>CB102479</p>	<p>PINO</p>  <p>1KR720</p>	<p>EIXO</p>  <p>102818 3/4</p>										
<p>EIXO</p>  <p>102818 7/8</p>	<p>HASTE</p>  <p>CBT P</p>	<p>HASTE</p>  <p>CBT M</p>	<p>HASTE</p>  <p>CBT G</p>										
<p>CARCAÇA DE ARTICULAÇÃO</p>  <p>1500901155</p>	<p>CARCAÇA DE ARTICULAÇÃO</p>  <p>1500901154</p>	<p>MANGAS DE EIXO</p>  <table border="1" data-bbox="982 975 1343 1156"> <tr> <td>070.0901.001 LD</td> <td>070.0901.002 LE</td> </tr> <tr> <td>100.0901.001 LD</td> <td>100.0901.002 LE</td> </tr> <tr> <td>210.0901.001 LD</td> <td>210.0901.002 LE</td> </tr> <tr> <td>251.0901.001 LD</td> <td>251.0901.002 LE</td> </tr> <tr> <td>310.0901.001 LD</td> <td>310.0901.002 LE</td> </tr> </table>		070.0901.001 LD	070.0901.002 LE	100.0901.001 LD	100.0901.002 LE	210.0901.001 LD	210.0901.002 LE	251.0901.001 LD	251.0901.002 LE	310.0901.001 LD	310.0901.002 LE
070.0901.001 LD	070.0901.002 LE												
100.0901.001 LD	100.0901.002 LE												
210.0901.001 LD	210.0901.002 LE												
251.0901.001 LD	251.0901.002 LE												
310.0901.001 LD	310.0901.002 LE												





















<p>BUCHA</p>  <p>3323260</p>	<p>CAPA DO ROLAMENTO</p>  <p>110520</p>	<p>PINO</p>  <p>103890</p>	<p>PINO</p>  <p>103929</p>
<p>PINO</p>  <p>107234</p>	<p>PINO</p>  <p>108796</p>	<p>PINO</p>  <p>112500</p>	<p>PINO</p>  <p>128513</p>
<p>PINO</p>  <p>323261</p>	<p>PINO</p>  <p>2347167</p>	<p>PINO</p>  <p>2360874</p>	<p>PINO</p>  <p>2388494</p>
<p>PINO</p>  <p>2789522</p>	<p>PINO</p>  <p>2791956</p>	<p>PINO</p>  <p>2805320</p>	<p>PINO</p>  <p>3312664</p>
<p>PINO</p>  <p>3314434</p>			





















<p>BUCHA</p>  <p>K1037849A</p>	<p>BUCHA</p>  <p>K1037852A</p>	<p>PINO</p>  <p>21232191B</p>	<p>FLANGE</p>  <p>K1000911</p>
<p>FLANGE</p>  <p>K1000912A</p>	<p>GRUPOS PARA ESTEIRAS</p>  <p>GR DX140 GR DX225</p>		







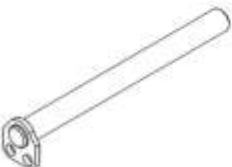

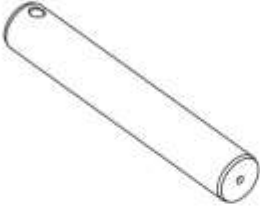

<p>BUCHA</p>  <p>4971690</p>	<p>BUCHA</p>  <p>587842</p>	<p>BUCHA</p>  <p>8271634</p>	<p>BUCHA</p>  <p>8280391</p>
<p>BUCHA</p>  <p>8285377</p>	<p>BUCHA</p>  <p>9967992</p>	<p>BUCHA</p>  <p>9967678</p>	<p>BUCHA</p>  <p>9967993</p>
<p>BUCHA</p>  <p>9968007</p>	<p>BUCHA</p>  <p>9968010</p>	<p>BUCHA</p>  <p>45006013</p>	<p>BUCHA</p>  <p>45007752</p>
<p>BUCHA</p>  <p>45007764</p>	<p>BUCHA</p>  <p>71400206</p>	<p>BUCHA</p>  <p>71400222</p>	<p>BUCHA</p>  <p>71415176</p>
<p>BUCHA</p>  <p>71415177</p>	<p>BUCHA</p>  <p>71415178</p>	<p>BUCHA</p>  <p>71415182</p>	<p>BUCHA</p>  <p>71418421</p>

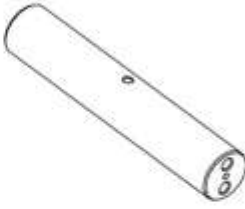

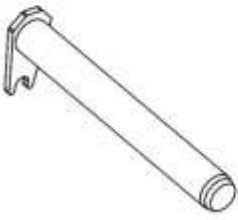
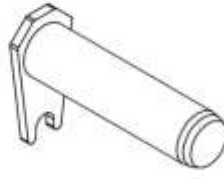

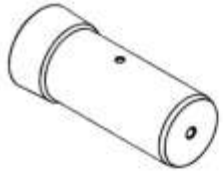
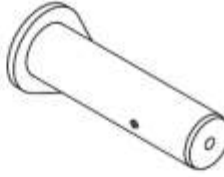



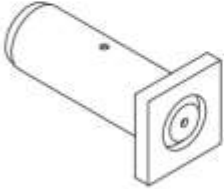

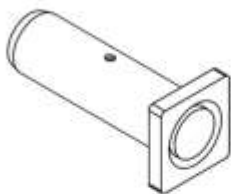
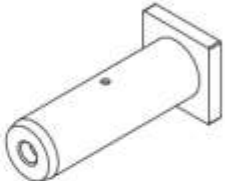
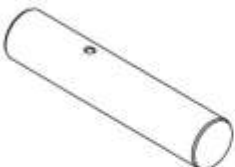

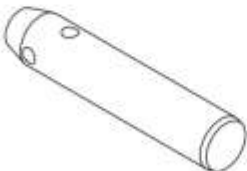

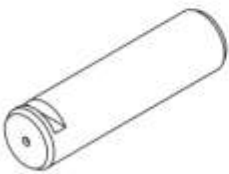
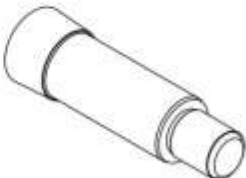
<p>BUCHA</p>  <p>71418493</p>	<p>BUCHA</p>  <p>71418583</p>	<p>BUCHA</p>  <p>71420064</p>	<p>BUCHA</p>  <p>71420065</p>
<p>BUCHA</p>  <p>73126245</p>	<p>BUCHA</p>  <p>73180081</p>	<p>BUCHA</p>  <p>73180105</p>	<p>BUCHA</p>  <p>73180106</p>
<p>BUCHA</p>  <p>75213115</p>	<p>BUCHA</p>  <p>75213179</p>	<p>BUCHA</p>  <p>75213209</p>	<p>BUCHA</p>  <p>75213214</p>
<p>BUCHA</p>  <p>75216487</p>	<p>BUCHA</p>  <p>75216645</p>	<p>BUCHA</p>  <p>75216651</p>	<p>BUCHA</p>  <p>75216668</p>
<p>BUCHA</p>  <p>75216676</p>	<p>BUCHA</p>  <p>75218127</p>	<p>BUCHA</p>  <p>75219071</p>	<p>BUCHA</p>  <p>75222313</p>

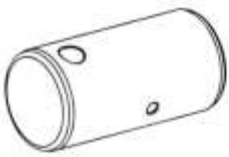



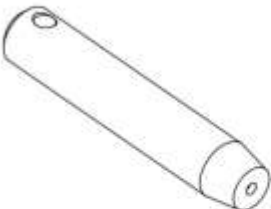

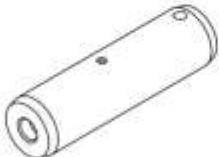
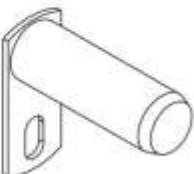



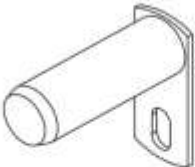

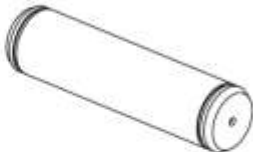



<p>BUCHA</p>  <p>75222645</p>	<p>BUCHA</p>  <p>75235420</p>	<p>BUCHA</p>  <p>75235421</p>	<p>BUCHA</p>  <p>75235424</p>
<p>BUCHA</p>  <p>75235386</p>	<p>BUCHA</p>  <p>75235395</p>	<p>BUCHA</p>  <p>75237948</p>	<p>BUCHA</p>  <p>75237949</p>
<p>BUCHA</p>  <p>75245378</p>	<p>BUCHA</p>  <p>75245999</p>	<p>BUCHA</p>  <p>75248202</p>	<p>BUCHA</p>  <p>75249552</p>
<p>BUCHA</p>  <p>75261187</p>	<p>BUCHA</p>  <p>76021404</p>	<p>BUCHA</p>  <p>76021466</p>	<p>BUCHA</p>  <p>76021470</p>
<p>BUCHA</p>  <p>76021473</p>	<p>BUCHA</p>  <p>76021555</p>	<p>BUCHA</p>  <p>76021584</p>	<p>BUCHA</p>  <p>76021677</p>

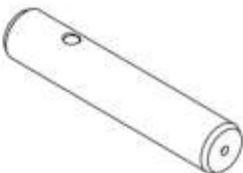
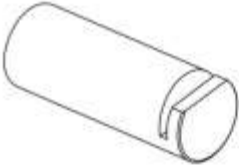
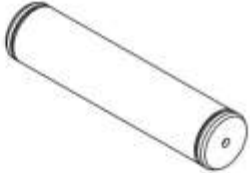

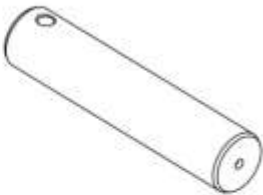





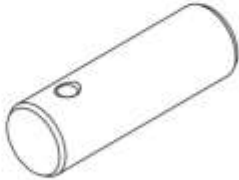

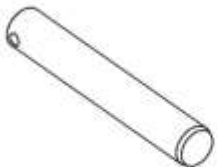
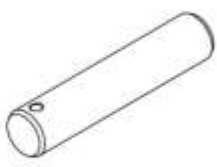
<p>BUCHA</p>  <p>76021680</p>	<p>BUCHA</p>  <p>76021869</p>	<p>BUCHA</p>  <p>76022051</p>	<p>BUCHA</p>  <p>76022055</p>
<p>BUCHA</p>  <p>76022096</p>	<p>BUCHA</p>  <p>76022114</p>	<p>BUCHA</p>  <p>76022325</p>	<p>BUCHA</p>  <p>76022616</p>
<p>BUCHA</p>  <p>76022698</p>	<p>BUCHA</p>  <p>76022681</p>	<p>BUCHA</p>  <p>79035549</p>	<p>BUCHA</p>  <p>79035550</p>
<p>BUCHA</p>  <p>79088197</p>	<p>BUCHA</p>  <p>81901809</p>	<p>BUCHA</p>  <p>81901896</p>	<p>BUCHA</p>  <p>81901897</p>
<p>BUCHA</p>  <p>81902174</p>	<p>BUCHA</p>  <p>83910546</p>	<p>BUCHA</p>  <p>83910547</p>	<p>BUCHA</p>  <p>83910548</p>

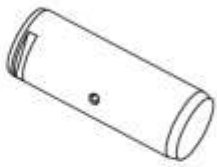
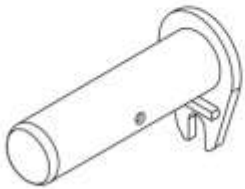
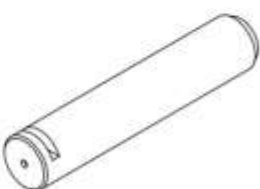
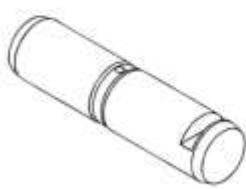
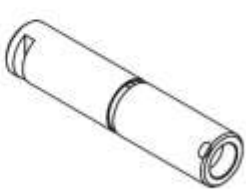





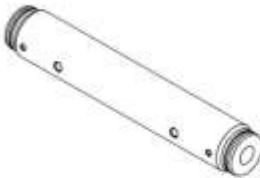
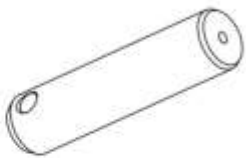

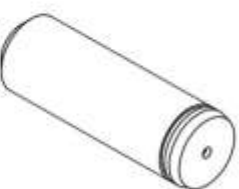
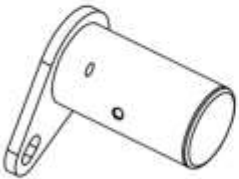
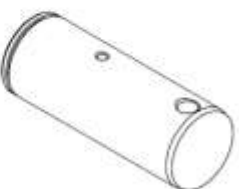

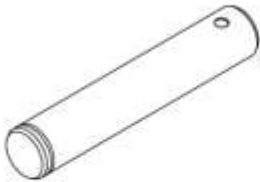

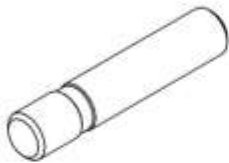

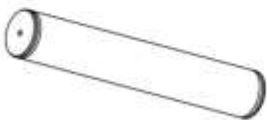

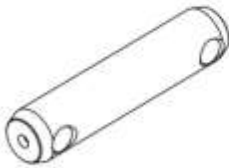

<p>BUCHA</p>  <p>83910551</p>	<p>BUCHA</p>  <p>83910557</p>	<p>BUCHA</p>  <p>83910558</p>	<p>BUCHA</p>  <p>83910634</p>
<p>BUCHA</p>  <p>83910645</p>	<p>BUCHA</p>  <p>83912378</p>	<p>BUCHA</p>  <p>83902710</p>	<p>BUCHA</p>  <p>85700728</p>
<p>BUCHA</p>  <p>85800202</p>	<p>BUCHA</p>  <p>85800303</p>	<p>BUCHA</p>  <p>85801029</p>	<p>BUCHA</p>  <p>85801110</p>
<p>BUCHA</p>  <p>85803193</p>	<p>BUCHA</p>  <p>85803196</p>	<p>BUCHA</p>  <p>85803197</p>	<p>BUCHA</p>  <p>87533342</p>
<p>PINO</p>  <p>71415092</p>	<p>PINO</p>  <p>73124680</p>	<p>PINO</p>  <p>73133514</p>	<p>PINO</p>  <p>73160978</p>

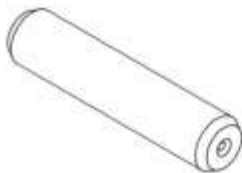

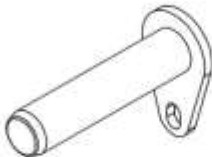

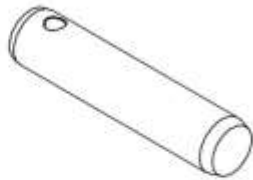

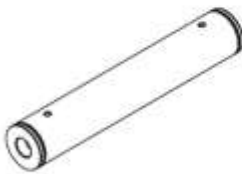



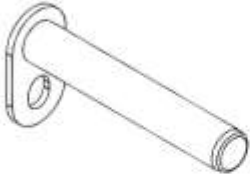
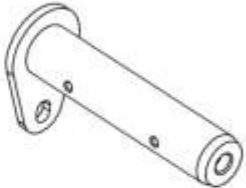

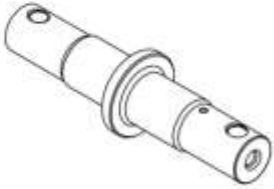

<p>PINO</p>  <p>75213252</p>	<p>PINO</p>  <p>75213254</p>	<p>PINO</p>  <p>75213255</p>	<p>PINO</p>  <p>75213256</p>
<p>PINO</p>  <p>75213600</p>	<p>PINO</p>  <p>75213765</p>	<p>PINO</p>  <p>75213902</p>	<p>PINO</p>  <p>75213903</p>
<p>PINO</p>  <p>75216516</p>	<p>PINO</p>  <p>75216669</p>	<p>PINO</p>  <p>75216674</p>	<p>PINO</p>  <p>75218505</p>
<p>PINO</p>  <p>75218611</p>	<p>PINO</p>  <p>75218614</p>	<p>PINO</p>  <p>75218644</p>	<p>PINO</p>  <p>75219869</p>
<p>PINO</p>  <p>75222646</p>	<p>PINO</p>  <p>75222647</p>	<p>PINO</p>  <p>75235393</p>	<p>PINO</p>  <p>75235488</p>

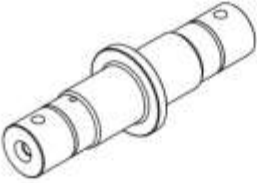
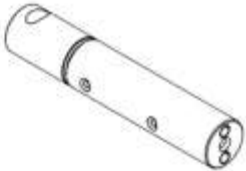
<p>PINO</p>  <p>75235498</p>	<p>PINO</p>  <p>75235499</p>	<p>PINO</p>  <p>75238951</p>	<p>PINO</p>  <p>75239508</p>
<p>PINO</p>  <p>75239509</p>	<p>PINO</p>  <p>75243855</p>	<p>PINO</p>  <p>75244172</p>	<p>PINO</p>  <p>75244564</p>
<p>PINO</p>  <p>75244608</p>	<p>PINO</p>  <p>75245372</p>	<p>PINO</p>  <p>75245373</p>	<p>PINO</p>  <p>75245379</p>
<p>PINO</p>  <p>75245455</p>	<p>PINO</p>  <p>75246111</p>	<p>PINO</p>  <p>75247594</p>	<p>PINO</p>  <p>75247595</p>
<p>PINO</p>  <p>75250515</p>	<p>PINO</p>  <p>75254214</p>	<p>PINO</p>  <p>75254217</p>	<p>PINO</p>  <p>75254221</p>









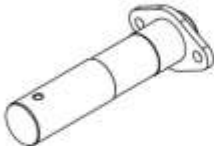
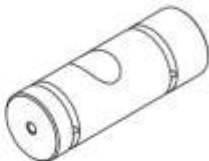
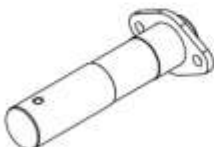

<p>PINO</p>  <p>75254408</p>	<p>PINO</p>  <p>75255825</p>	<p>PINO</p>  <p>75263667</p>	<p>PINO</p>  <p>76021436</p>
<p>PINO</p>  <p>76021461</p>	<p>PINO</p>  <p>76021463</p>	<p>PINO</p>  <p>76021546</p>	<p>PINO</p>  <p>76021553</p>
<p>PINO</p>  <p>76021650</p>	<p>PINO</p>  <p>76021727</p>	<p>PINO</p>  <p>76021753</p>	<p>PINO</p>  <p>76021883</p>
<p>PINO</p>  <p>76021937</p>	<p>PINO</p>  <p>76021939</p>	<p>PINO</p>  <p>76022298</p>	<p>PINO</p>  <p>76022682</p>
<p>PINO</p>  <p>76022683</p>	<p>PINO</p>  <p>76022684</p>	<p>PINO</p>  <p>76022685</p>	<p>PINO</p>  <p>76022740</p>













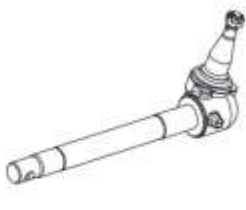





<p>PINO</p>  <p>76022741</p>	<p>PINO</p>  <p>76022743</p>	<p>PINO</p>  <p>79106029</p>	<p>PINO</p>  <p>79106030</p>
<p>PINO</p>  <p>79106037</p>	<p>PINO</p>  <p>8273214</p>	<p>PINO</p>  <p>8280936</p>	<p>PINO</p>  <p>8284858</p>
<p>PINO</p>  <p>83911000</p>	<p>PINO</p>  <p>83959693</p>	<p>PINO</p>  <p>83959695</p>	<p>PINO</p>  <p>83999466</p>
<p>PINO</p>  <p>84980892</p>	<p>PINO</p>  <p>84996279</p>	<p>PINO</p>  <p>85801026</p>	<p>PINO</p>  <p>85801049</p>
<p>PINO</p>  <p>85801050</p>	<p>PINO</p>  <p>85801056</p>	<p>PINO</p>  <p>85801076</p>	<p>PINO</p>  <p>85801079</p>





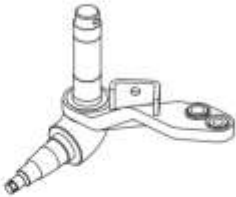















<p>PINO</p>  <p>85801086</p>	<p>PINO</p>  <p>85801087</p>	<p>PINO</p>  <p>85801097</p>	<p>PINO</p>  <p>85801262</p>
<p>PINO</p>  <p>85801308</p>	<p>PINO</p>  <p>85801309</p>	<p>PINO</p>  <p>85801314</p>	<p>PINO</p>  <p>85802870</p>
<p>PINO</p>  <p>85802871</p>	<p>PINO</p>  <p>85802872</p>	<p>PINO</p>  <p>85802993</p>	<p>PINO</p>  <p>85802994</p>
<p>PINO</p>  <p>85803002</p>	<p>PINO</p>  <p>85803005</p>	<p>PINO</p>  <p>85803141</p>	<p>PINO</p>  <p>85803192</p>
<p>PINO</p>  <p>85803194</p>	<p>PINO</p>  <p>85803246</p>	<p>PINO</p>  <p>85813469</p>	<p>PINO</p>  <p>85815517</p>











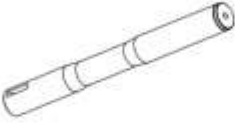





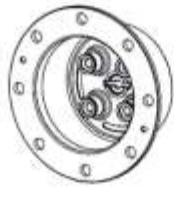

<p>PINO</p>  <p>85815607</p>	<p>PINO</p>  <p>85815698</p>	<p>EIXO</p>  <p>592564</p>	<p>EIXO</p>  <p>4963951</p>
<p>EIXO</p>  <p>4964254</p>	<p>EIXO</p>  <p>4972921</p>	<p>EIXO</p>  <p>4979789</p>	<p>EIXO</p>  <p>71400914</p>
<p>EIXO</p>  <p>75210210</p>	<p>EIXO</p>  <p>75244684</p>	<p>EIXO</p>  <p>75244685</p>	<p>EIXO</p>  <p>76001769</p>
<p>EIXO</p>  <p>79023010</p>	<p>ESPAÇADOR</p>  <p>554922</p>	<p>ESPAÇADOR</p>  <p>986424</p>	<p>MANCAL</p>  <p>75201430</p>
<p>GRUPOS PARA ESTEIRAS - LISO</p>  <p>GR FX215 GR AD7 53 GR AD7 52 PFM GR AD7 53 PFM GR AD9 GR AD14 GR E215</p> <p>GR FD9 GR FD170 GR FH200 GR FH220 GR FH240 GR S90</p>		<p>GRUPOS PARA ESTEIRAS - COM RESSALTO</p>  <p>GR AD7 CR GR AD14 CS 3R FD170 CR</p>	







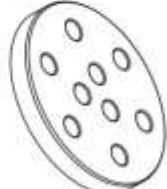

<p>BUCHA</p>  <p>9967999</p>	<p>BUCHA</p>  <p>51335961</p>	<p>BUCHA</p>  <p>81802797</p>	<p>BUCHA</p>  <p>81805744</p>
<p>BUCHA</p>  <p>84996852</p>	<p>BUCHA</p>  <p>84996853</p>	<p>BUCHA</p>  <p>87543300</p>	<p>BUCHA</p>  <p>C5NN3110A</p>
<p>BUCHA</p>  <p>C5NN3179A</p>	<p>ARRUELA</p>  <p>84058000</p>	<p>ARRUELA</p>  <p>85801191</p>	<p>PINO</p>  <p>393710</p>
<p>PINO</p>  <p>825949</p>	<p>PINO (FORJADO)</p>  <p>9579265</p>	<p>PINO</p>  <p>81802838</p>	<p>PINO</p>  <p>81814506</p>
<p>PINO</p>  <p>83947640</p>	<p>PINO</p>  <p>85806011/C</p>	<p>PINO</p>  <p>85806011/P</p>	<p>PINO</p>  <p>159A</p>

<p>PINO</p>  <p>160A</p>	<p>PINO</p>  <p>3126A</p>	<p>PINO</p>  <p>159AA</p>	<p>PINO</p>  <p>C5NN3N703</p>
<p>PINO</p>  <p>C5NN3N159A</p>	<p>PINO</p>  <p>C5NN3N160A</p>	<p>PINO</p>  <p>E4NN3126A</p>	<p>PINO</p>  <p>E6NN3N160AA</p>
<p>PINO (FORJADO)</p>  <p>RZP4472352162</p>	<p>EIXO</p>  <p>83918635</p>	<p>EIXO</p>  <p>D3NN544A</p>	<p>EIXO</p>  <p>D9NN544AA</p>
<p>EIXO</p>  <p>D9NN544AB</p>	<p>EIXO</p>  <p>E3NN544AB</p>	<p>PONTA DO EIXO</p>  <p>C5NN7A684A1 (15 DENTES)</p>	<p>PONTA DE EIXO</p>  <p>E4NN7A684AA (20 DENTES)</p>
<p>MANGA DE EIXO</p>  <p>449793 LD</p>	<p>MANGA DE EIXO</p>  <p>449792 LE</p>	<p>MANGA DE EIXO</p>  <p>9575634</p>	<p>MANGA DE EIXO</p>  <p>9575635</p>

<p>MANGA DE EIXO</p>  <p>9576485</p>	<p>MANGA DE EIXO</p>  <p>9576486</p>	<p>MANGA DE EIXO</p>  <p>9576487</p>	<p>MANGA DE EIXO</p>  <p>9576488</p>
<p>MANGA DE EIXO</p>  <p>9576510</p>	<p>MANGA DE EIXO</p>  <p>9576511</p>	<p>MANGA DE EIXO</p>  <p>81815914</p>	<p>MANGA DE EIXO</p>  <p>81815915</p>
<p>MANGA DE EIXO</p>  <p>82981359</p>	<p>MANGA DE EIXO</p>  <p>83905485</p>	<p>MANGA DE EIXO</p>  <p>83905486</p>	<p>MANGA DE EIXO</p>  <p>84120646 LD</p>
<p>MANGA DE EIXO</p>  <p>84120647 LE</p>	<p>MANGA DE EIXO</p>  <p>84992229 LD</p>	<p>MANGA DE EIXO</p>  <p>84992230 LE</p>	<p>MANGA DE EIXO</p>  <p>84997975 LD</p>
<p>MANGA DE EIXO</p>  <p>84997976 LE</p>	<p>MANGA DE EIXO</p>  <p>3107EA LD</p>	<p>MANGA DE EIXO</p>  <p>3107FA LD</p>	<p>MANGA DE EIXO</p>  <p>3108DA LE</p>

<p>MANGA DE EIXO</p>  <p>3108EA LE</p>	<p>MANGA DE EIXO</p>  <p>3108FA LE</p>	<p>MANGA DE EIXO</p>  <p>3107GA LD</p>	<p>MANGA DE EIXO</p>  <p>C5NN3105M</p>
<p>MANGA DE EIXO</p>  <p>C5NN3106J</p>	<p>MANGA DE EIXO</p>  <p>D4NN3105A</p>	<p>MANGA DE EIXO</p>  <p>D4NN3106A</p>	<p>MANGA DE EIXO</p>  <p>E5NN3108FA</p>
<p>HASTE MANGA DE EIXO</p>  <p>HASTE 9575634</p>	<p>HASTE MANGA DE EIXO</p>  <p>HASTE 9575635</p>	<p>HASTE MANGA DE EIXO</p>  <p>HASTE 9576485</p>	<p>HASTE MANGA DE EIXO</p>  <p>HASTE 9576486</p>
<p>HASTE MANGA DE EIXO</p>  <p>HASTE 9576487</p>	<p>HASTE MANGA DE EIXO</p>  <p>HASTE 9576488</p>	<p>HASTE MANGA DE EIXO</p>  <p>HASTE 9576510</p>	<p>HASTE MANGA DE EIXO</p>  <p>HASTE 9576511</p>
<p>HASTE MANGA DE EIXO</p>  <p>HASTE 3107EA</p>	<p>HASTE MANGA DE EIXO</p>  <p>HASTE 3107FA</p>	<p>HASTE MANGA DE EIXO</p>  <p>HASTE 3108DA</p>	<p>HASTE MANGA DE EIXO</p>  <p>HASTE 3108EA</p>

<p>HASTE MANGA DE EIXO</p>  <p>HASTE 3108FA</p>	<p>HASTE MANGA DE EIXO</p>  <p>HASTE 3107GA</p>	<p>CARCAÇA DE ARTICULAÇÃO</p>  <p>5173281 LE</p>	<p>CARCAÇA DE ARTICULAÇÃO</p>  <p>5173285 LD</p>
<p>CARCAÇA DE ARTICULAÇÃO</p>  <p>85805981 LE</p>	<p>CARCAÇA DE ARTICULAÇÃO</p>  <p>85805985 LD</p>	<p>CARCAÇA DE ARTICULAÇÃO</p>  <p>85824348 LD</p>	<p>CARCAÇA DE ARTICULAÇÃO</p>  <p>85824349 LE</p>
<p>PORTADOR PLANETÁRIO</p>  <p>9579264</p>	<p>PORTADOR PLANETÁRIO</p>  <p>RZP4472352103</p>	<p>PORTADOR PLANETÁRIO</p>  <p>85806011</p>	<p>CUBO</p>  <p>85806003</p>
<p>ENGRENAGEM</p>  <p>85806014</p>	<p>FLANGE</p>  <p>81801947</p>	<p>FLANGE</p>  <p>81819815</p>	<p>FLANGE</p>  <p>83903432</p>
<p>FLANGE</p>  <p>83929926</p>	<p>FLANGE</p>  <p>83936827</p>	<p>FLANGE</p>  <p>83947159</p>	<p>FLANGE</p>  <p>87310327</p>

<p>FLANGE</p>  <p>87310380</p>	<p>FLANGE</p>  <p>C5NNN777A (15 DENTES)</p>	<p>FLANGE</p>  <p>C7NNN777A</p>	<p>FLANGE</p>  <p>C7NNN778A</p>
<p>FLANGE</p>  <p>E1NNN777AA</p>	<p>FLANGE</p>  <p>E1NNN777AB (20 DENTES)</p>	<p>FLANGE</p>  <p>E2NNN777AA</p>	<p>PORCA</p>  <p>9579221</p>
<p>GRUPO PARA ESTEIRA</p>  <p>GR D150</p>			

KIT - LB90 DIANTEIRO (KT LB90 D)

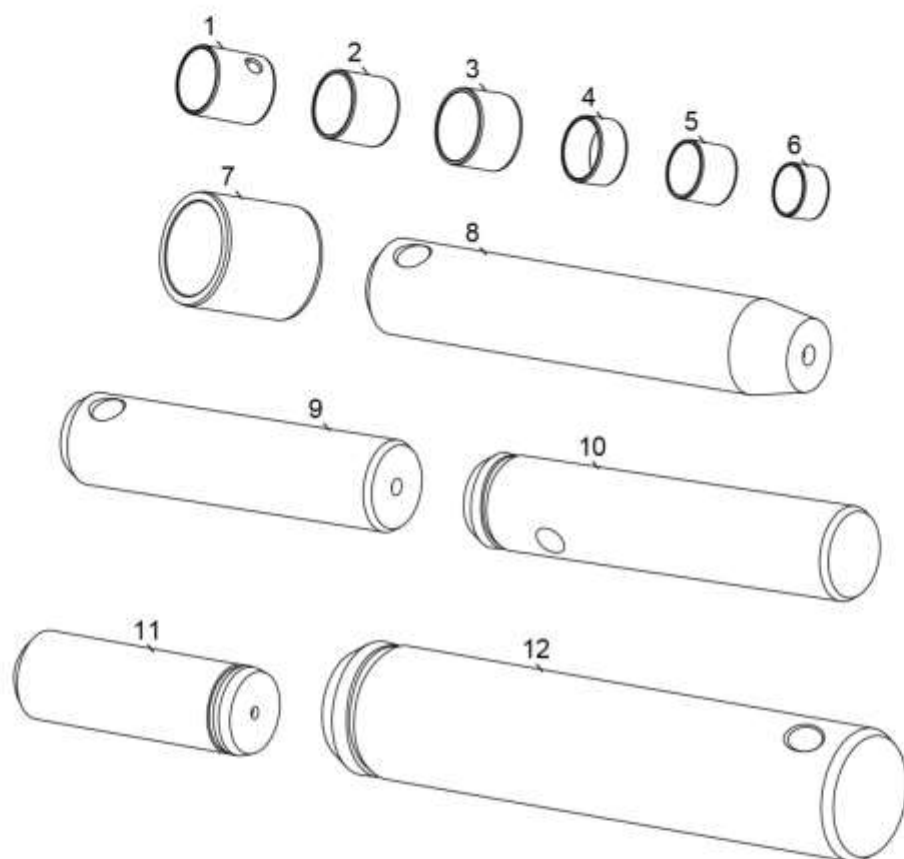

POS.	CÓDIGO
1	75248202
2	81901809
3	81901896
4	81901897
5	81902174
6	83902710
7	85801110
8	75247594
9	85801049
10	85801050
11	85801056
12	85801086

KIT - LB90 TRASEIRO

(KT LB90 T)

POS.	CÓDIGO
1	85802993
2	85815517
3	85815607
4	83911000
5	85815698
6	83999466
7	85801026
8	85801076
9	85801079
10	85801262
11	85802872
12	85803002
13	85803005
14	85803141
15	85803192
16	85813469
17	83910645
18	83912378
19	83910546
20	76021466
21	83910547
22	83910548
23	83910551
24	83910557
25	83910558
26	83910634
27	85700728
28	85800202
29	85800303
30	85801029
31	85803193
32	85803196
33	85803197

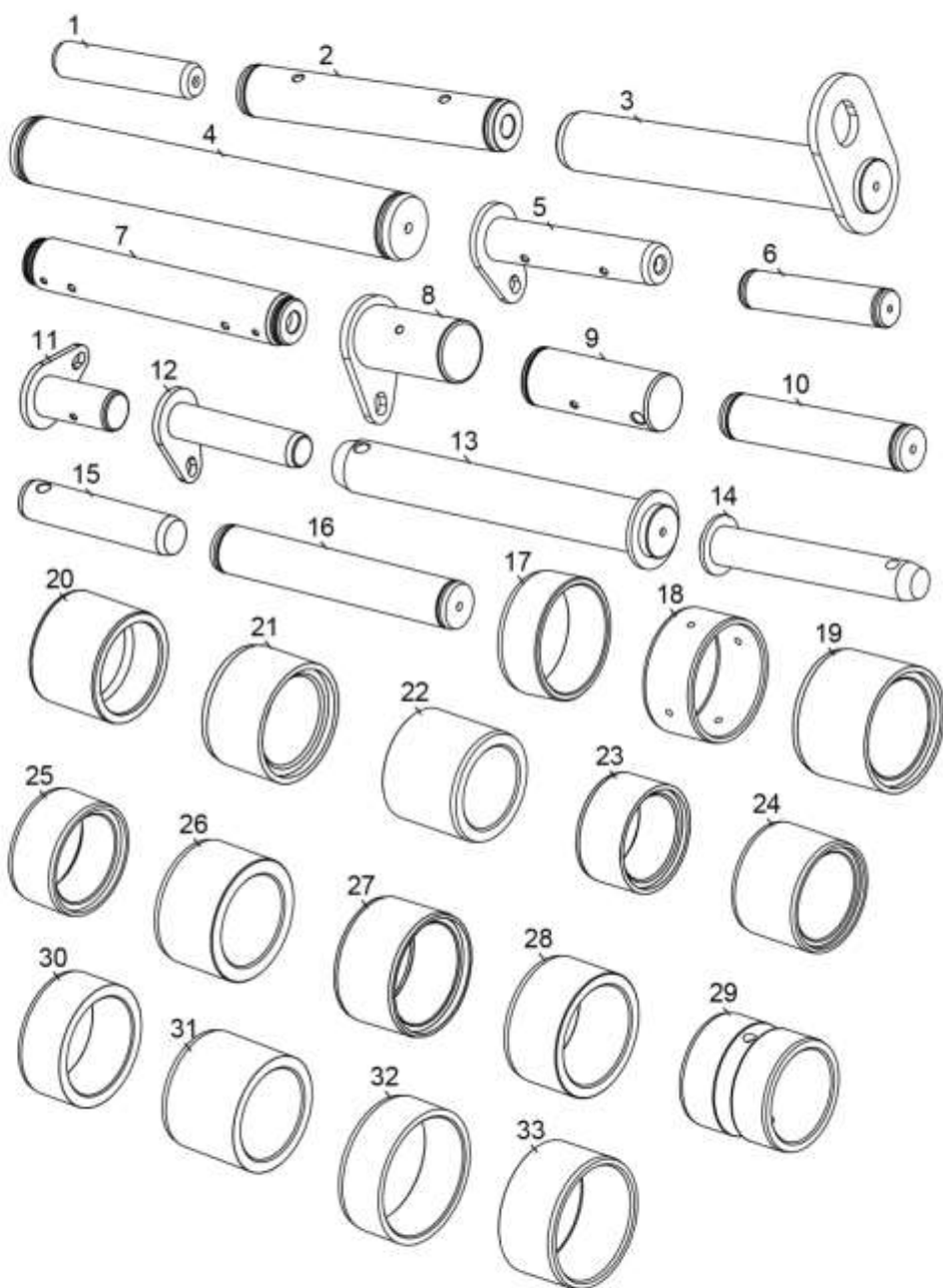

BRAÇO DA MANGA DE EIXO















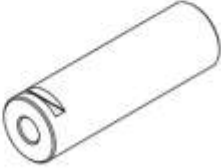



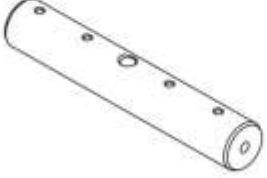
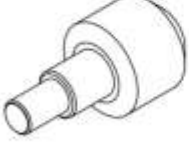

6300028



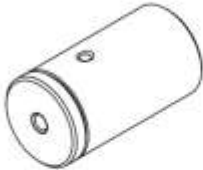
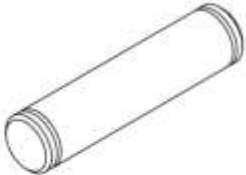

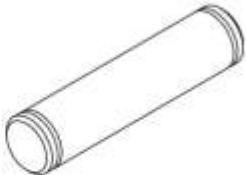
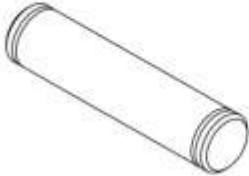

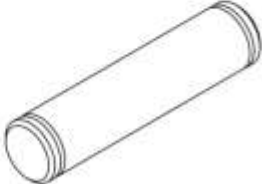









BRAÇO DA MANGA DE EIXO







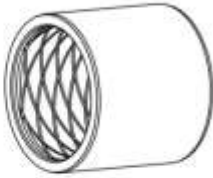

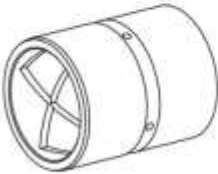
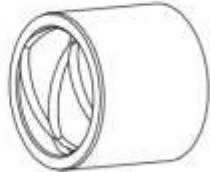



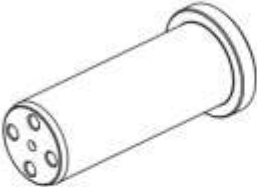



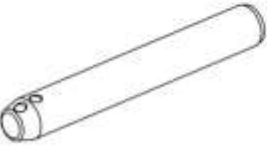

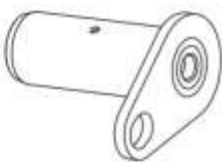



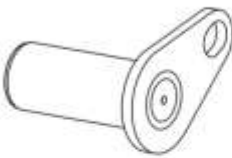
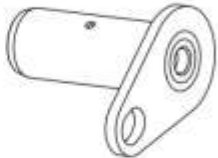
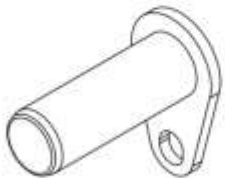





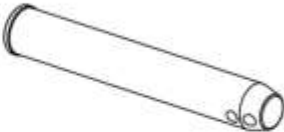

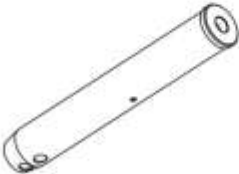
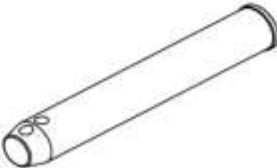
6300029



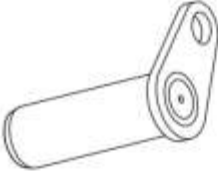

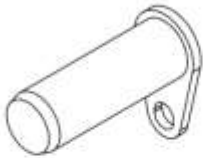
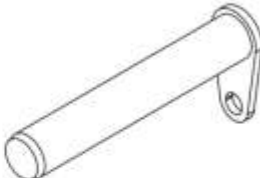

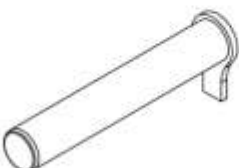
<p>BUCHA</p>  <p>300766</p>	<p>BUCHA</p>  <p>300982</p>	<p>BUCHA</p>  <p>323260</p>	<p>ROLDANA</p>  <p>346906</p>
<p>CAPA ROLAMENTO</p>  <p>185530</p>	<p>CAPA ROLAMENTO</p>  <p>185531</p>	<p>CAPA ROLAMENTO</p>  <p>193557</p>	<p>PINO</p>  <p>25635</p>
<p>PINO</p>  <p>112209</p>	<p>PINO</p>  <p>129259</p>	<p>PINO</p>  <p>162598</p>	<p>PINO</p>  <p>196445</p>
<p>PINO</p>  <p>248461</p>	<p>PINO</p>  <p>248465</p>	<p>PINO</p>  <p>300765</p>	<p>PINO</p>  <p>326498</p>
<p>PINO</p>  <p>804693</p>	<p>PINO</p>  <p>807526</p>	<p>PINO</p>  <p>809052</p>	<p>PINO</p>  <p>809111</p>

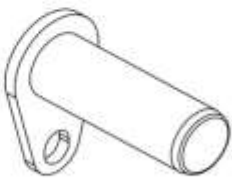

<p>PINO</p>  <p>820550</p>	<p>PINO</p>  <p>1544970</p>	<p>PINO</p>  <p>1568270</p>	<p>PINO</p>  <p>1568271</p>
<p>PINO</p>  <p>1568272</p>	<p>PINO</p>  <p>1570303</p>	<p>PINO</p>  <p>1673481</p>	<p>PINO</p>  <p>1673482</p>
<p>PINO</p>  <p>2772639</p>			

<p>BUCHA</p>  <p>31YC11115</p>	<p>BUCHA</p>  <p>31YC11141</p>	<p>BUCHA</p>  <p>31YC11240</p>	<p>BUCHA</p>  <p>31YC13150</p>
<p>BUCHA</p>  <p>41LF10160</p>	<p>BUCHA</p>  <p>61EN12200</p>	<p>BUCHA</p>  <p>61EN12230</p>	<p>BUCHA</p>  <p>61EN13310</p>
<p>BUCHA</p>  <p>61EN13360</p>	<p>BUCHA</p>  <p>61LF10090</p>	<p>BUCHA</p>  <p>61Q604000</p>	<p>BUCHA</p>  <p>61Q604010</p>
<p>BUCHA</p>  <p>61Q604040</p>	<p>BUCHA</p>  <p>61Q605000</p>	<p>BUCHA</p>  <p>61Q605570</p>	<p>BUCHA</p>  <p>61QH89130</p>
<p>BUCHA</p>  <p>X112702063</p>	<p>BUCHA</p>  <p>X114802100</p>	<p>BUCHA</p>  <p>X114802120</p>	<p>BUCHA</p>  <p>X124652069</p>

<p>BUCHA</p>  <p>X124702100</p>	<p>BUCHA</p>  <p>X124802100</p>	<p>PINO</p>  <p>41L710020</p>	<p>PINO</p>  <p>41LF10111</p>
<p>PINO</p>  <p>61E312060</p>	<p>PINO</p>  <p>61E312061</p>	<p>PINO</p>  <p>61EK11102</p>	<p>PINO</p>  <p>61EK11111</p>
<p>PINO</p>  <p>61EM00111</p>	<p>PINO</p>  <p>61LB15040</p>	<p>PINO</p>  <p>61LB15050</p>	<p>PINO</p>  <p>61LB15060</p>
<p>PINO</p>  <p>61LB15070</p>	<p>PINO</p>  <p>61LB15200</p>	<p>PINO</p>  <p>61LB15210</p>	<p>PINO</p>  <p>61LB15220</p>
<p>PINO</p>  <p>61LM15030</p>	<p>PINO</p>  <p>61LM15200</p>	<p>PINO</p>  <p>61LM15210</p>	<p>PINO</p>  <p>61N411091</p>

<p>PINO</p>  <p>61N411101</p>	<p>PINO</p>  <p>61N411131</p>	<p>PINO</p>  <p>61N511081</p>	<p>PINO</p>  <p>61N611081</p>
<p>PINO</p>  <p>61N611082</p>	<p>PINO</p>  <p>61N611091</p>	<p>PINO</p>  <p>61N611100</p>	<p>PINO</p>  <p>61N611101</p>
<p>PINO</p>  <p>61N611111</p>	<p>PINO</p>  <p>61N611112</p>	<p>PINO</p>  <p>61N801431</p>	<p>PINO</p>  <p>61N801600</p>
<p>PINO</p>  <p>61N801610</p>	<p>PINO</p>  <p>61N801730</p>	<p>PINO</p>  <p>61Q600010</p>	<p>PINO</p>  <p>61Q600011</p>
<p>PINO</p>  <p>61Q600020</p>	<p>PINO</p>  <p>61Q601410</p>	<p>PINO</p>  <p>61Q601600</p>	<p>PINO</p>  <p>61Q601610</p>

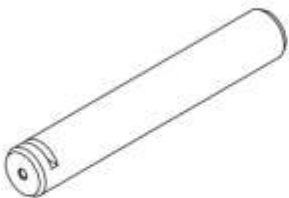
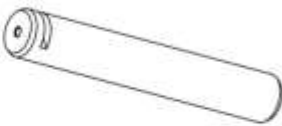
<p>PINO</p>  <p>61Q601620</p>	<p>PINO</p>  <p>61Q640050</p>	<p>PINO</p>  <p>61Q640060</p>	<p>PINO</p>  <p>Q100325000</p>
<p>EIXO</p>  <p>81N613110</p>	<p>FLANGE</p>  <p>61Q621301</p>	<p>GRUPOS PARA ESTEIRAS</p>  <ul style="list-style-type: none"> GR R80 GR R140 LC7 GR R140 LC9 GR R160 GR R210 GR R210 139 GR R210 ITM 	

<p>PINO</p>  <p>522748</p>	<p>PINO</p>  <p>642793</p>	<p>HASTE</p>  <p>559807</p>	<p>HASTE</p>  <p>6551152</p>
--	--	--	--

CONJUNTO CARÇAÇA DE ARTICULAÇÃO PARA MÁQUINAS AGRALE

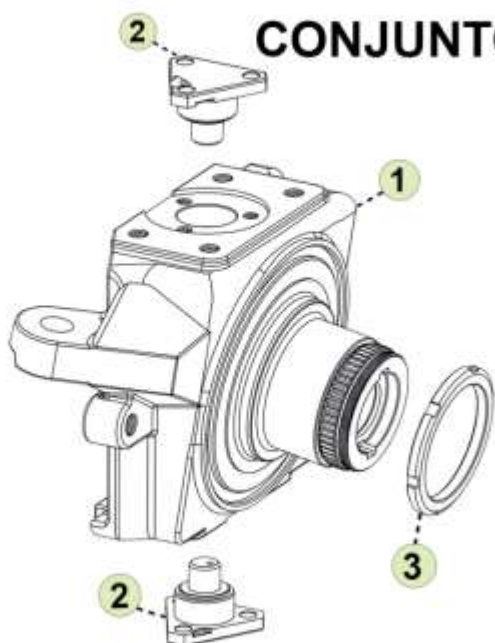

CARÇAÇA DE ARTICULAÇÃO
CQ27249 LE
CQ27248 LD









PIVÔ
CQ27251



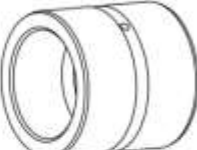
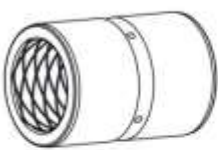
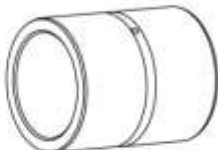
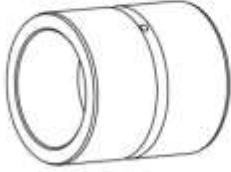

CARÇAÇA DE ARTICULAÇÃO
CQ36984 LE
CQ36985 LD





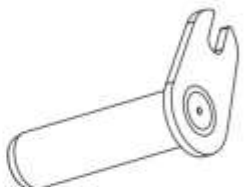

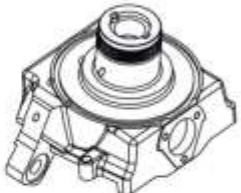

PORCA
T116822

ACOMPANHA

POS.	QTD.	DESCRIÇÃO
1	01	Carçaça de Articulação
2	02	Pivô
3	01	Porca





















<p>BUCHA</p>  <p>4409122</p>	<p>BUCHA</p>  <p>4409178</p>	<p>BUCHA</p>  <p>CQ29320</p>	<p>BUCHA</p>  <p>CQ29359</p>
<p>BUCHA</p>  <p>IB00407166</p>	<p>BUCHA</p>  <p>T228825</p>	<p>BUCHA</p>  <p>T228826</p>	<p>BUCHA</p>  <p>T228833</p>
<p>BUCHA</p>  <p>T361541</p>	<p>PORCA</p>  <p>0151340059</p>	<p>PORCA</p>  <p>CQ27377</p>	<p>PORCA</p>  <p>L60094</p>





















<p>PORCA</p>  <p>T116822</p>	<p>PINO</p>  <p>0121322176</p>	<p>PINO</p>  <p>AT301543</p>	<p>PINO</p>  <p>AT308025</p>
<p>PINO</p>  <p>AT308031</p>	<p>PINO</p>  <p>AT308032</p>	<p>PINO</p>  <p>FF803495</p>	<p>PINO</p>  <p>FF803496</p>
<p>PINO</p>  <p>FF850211</p>	<p>PINO</p>  <p>FF850230</p>	<p>PINO</p>  <p>L111817</p>	<p>PIVÓ (FORJADO)</p>  <p>CQ27251</p>
<p>PIVÓ</p>  <p>CB11419911</p>	<p>EIXO</p>  <p>0161339044</p>	<p>MANGA DE EIXO</p>  <p>CQ10770</p>	<p>MANGA DE EIXO</p>  <p>CQ10770 R</p>
<p>MANGA DE EIXO</p>  <p>DQ66071 LD</p>	<p>MANGA DE EIXO</p>  <p>DQ66072 LE</p>	<p>CARCAÇA DE ARTICULAÇÃO</p>  <p>CQ27248 LD</p>	<p>CARCAÇA DE ARTICULAÇÃO</p>  <p>CQ27249 LE</p>





















<p>CARCAÇA DE ARTICULAÇÃO</p>  <p>CQ36984 LE</p>	<p>CARCAÇA DE ARTICULAÇÃO</p>  <p>CQ36985 LD</p>	<p>PORTADOR PLANETÁRIO</p>  <p>CQ27407</p>	<p>PORTADOR PLANETÁRIO</p>  <p>CQ72047</p>
<p>PORTADOR PLANETÁRIO</p>  <p>CQ72048</p>	<p>PORTADOR PLANETÁRIO</p>  <p>L40012</p>	<p>PORTADOR PLANETÁRIO</p>  <p>L41121</p>	<p>ENGRENAGEM</p>  <p>ER125488</p>
<p>GRUPOS PARA ESTEIRAS</p>  <p>GR 700J GR 750J</p>			





















<p>BUCHA</p>  <p>0714310505</p>	<p>BUCHA</p>  <p>0714310506</p>	<p>BUCHA</p>  <p>0714310606</p>	<p>BUCHA</p>  <p>0714310707</p>
<p>BUCHA</p>  <p>0714410404</p>	<p>BUCHA</p>  <p>0714410506</p>	<p>BUCHA</p>  <p>0714410607</p>	<p>BUCHA</p>  <p>1242751241</p>
<p>BUCHA</p>  <p>1243251190</p>	<p>BUCHA</p>  <p>1302212141</p>	<p>BUCHA</p>  <p>1306312660</p>	<p>BUCHA</p>  <p>1307045170</p>
<p>BUCHA</p>  <p>1311445192</p>	<p>BUCHA</p>  <p>1317837150</p>	<p>BUCHA</p>  <p>1343052144</p>	<p>BUCHA</p>  <p>1343261140</p>
<p>BUCHA</p>  <p>1345061140</p>	<p>BUCHA</p>  <p>1345061150</p>	<p>BUCHA</p>  <p>1347271850</p>	<p>BUCHA</p>  <p>1352712250</p>



















<p>BUCHA</p>  <p>1407013130</p>	<p>BUCHA</p>  <p>1412712640</p>	<p>BUCHA</p>  <p>1417811311</p>	<p>BUCHA</p>  <p>1441311750</p>
<p>BUCHA</p>  <p>1445011120</p>	<p>BUCHA</p>  <p>1446015431</p>	<p>BUCHA</p>  <p>1453031250</p>	<p>BUCHA</p>  <p>1987121880</p>
<p>BUCHA</p>  <p>2033261140</p>	<p>BUCHA</p>  <p>2033261170</p>	<p>BUCHA</p>  <p>2037042182</p>	<p>BUCHA</p>  <p>2037056130</p>
<p>BUCHA</p>  <p>2037056140</p>	<p>BUCHA</p>  <p>2037056150</p>	<p>BUCHA</p>  <p>2037056160</p>	<p>BUCHA</p>  <p>2057065762</p>
<p>BUCHA</p>  <p>2057066550</p>	<p>BUCHA</p>  <p>2057067150</p>	<p>BUCHA</p>  <p>2057071360</p>	<p>BUCHA</p>  <p>2057072130</p>





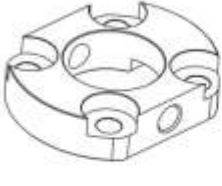
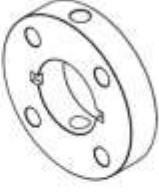



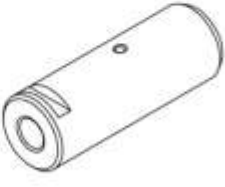

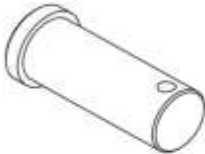
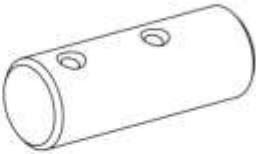
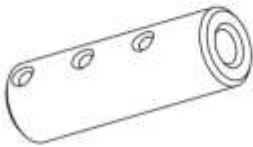

<p>BUCHA</p>  <p>2057072180</p>	<p>BUCHA</p>  <p>2057073180</p>	<p>BUCHA</p>  <p>2057074381</p>	<p>BUCHA</p>  <p>2059457150</p>
<p>BUCHA</p>  <p>2067053150</p>	<p>BUCHA</p>  <p>2067055280</p>	<p>BUCHA</p>  <p>2077031222</p>	<p>BUCHA</p>  <p>2077032140</p>
<p>BUCHA</p>  <p>2077034230</p>	<p>BUCHA</p>  <p>2077061521</p>	<p>BUCHA</p>  <p>2077072460</p>	<p>BUCHA</p>  <p>2077072470</p>
<p>BUCHA</p>  <p>2079347261</p>	<p>BUCHA</p>  <p>2087032140</p>	<p>BUCHA</p>  <p>2087072170</p>	<p>BUCHA</p>  <p>4167011810</p>
<p>BUCHA</p>  <p>4174622210</p>	<p>BUCHA</p>  <p>4177011860</p>	<p>BUCHA</p>  <p>4177031820</p>	<p>BUCHA</p>  <p>4184611160</p>

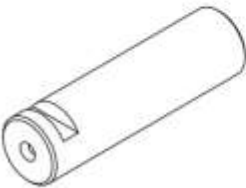
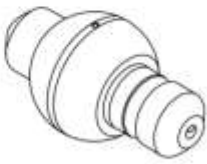

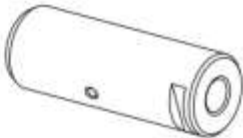
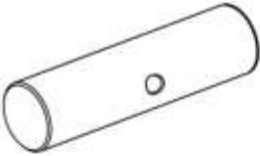

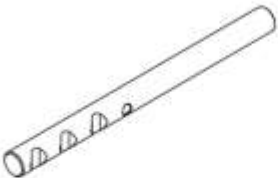

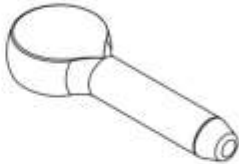

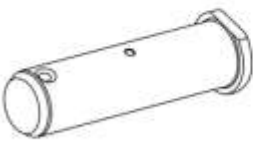
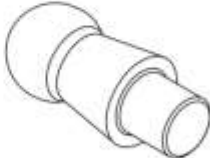
<p>BUCHA</p>  <p>4186333140</p>	<p>BUCHA</p>  <p>4187011860</p>	<p>BUCHA</p>  <p>4194611170</p>	<p>BUCHA</p>  <p>4194611180</p>
<p>BUCHA</p>  <p>4197011810</p>	<p>BUCHA</p>  <p>4197011820</p>	<p>BUCHA</p>  <p>4197011871</p>	<p>BUCHA</p>  <p>4197011890</p>
<p>BUCHA</p>  <p>4197021810</p>	<p>BUCHA</p>  <p>4197031810</p>	<p>BUCHA</p>  <p>4197031870</p>	<p>BUCHA</p>  <p>4247011870</p>
<p>BUCHA</p>  <p>6631214311</p>	<p>BUCHA</p>  <p>7077610140</p>	<p>BUCHA</p>  <p>7077611121</p>	<p>BUCHA</p>  <p>7077640020</p>
<p>BUCHA</p>  <p>7077645020</p>	<p>BUCHA</p>  <p>7077650152</p>	<p>BUCHA</p>  <p>7077665220</p>	<p>BUCHA</p>  <p>7077665580</p>

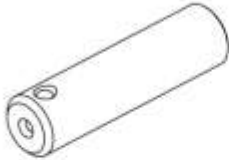
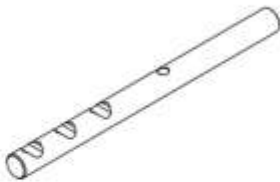
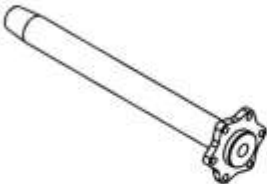
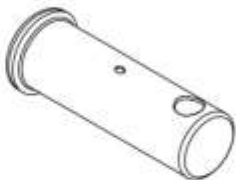
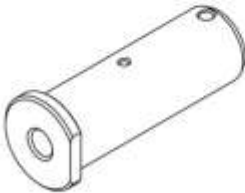



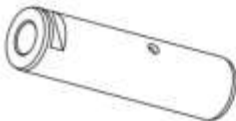
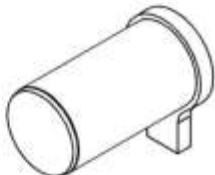
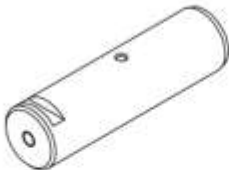
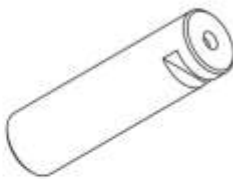

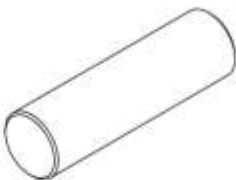
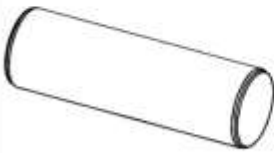





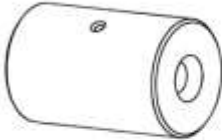

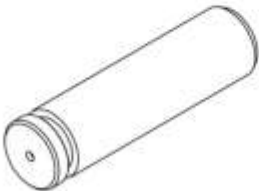

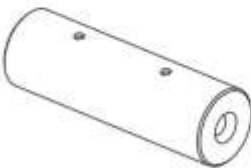

<p>BUCHA</p>  <p>7077670080</p>	<p>BUCHA</p>  <p>7077670110</p>	<p>BUCHA</p>  <p>7077670120</p>	<p>BUCHA</p>  <p>7077670160</p>
<p>BUCHA</p>  <p>7077670230</p>	<p>BUCHA</p>  <p>7077670330</p>	<p>BUCHA</p>  <p>7077670370</p>	<p>BUCHA</p>  <p>7077675030</p>
<p>BUCHA</p>  <p>7077675060</p>	<p>BUCHA</p>  <p>7077680010</p>	<p>BUCHA</p>  <p>7077680020</p>	<p>BUCHA</p>  <p>7077680230</p>
<p>BUCHA</p>  <p>7077680470</p>	<p>BUCHA</p>  <p>23A2711620</p>	<p>BUCHA</p>  <p>23A2711630</p>	<p>BUCHA</p>  <p>22B7023610</p>
<p>BUCHA</p>  <p>22B7023630</p>	<p>BUCHA</p>  <p>22B7023640</p>	<p>BUCHA</p>  <p>22B7023650</p>	<p>BUCHA</p>  <p>22B7023660</p>

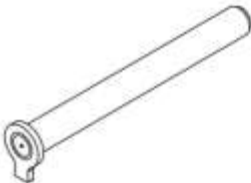

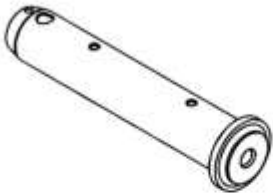

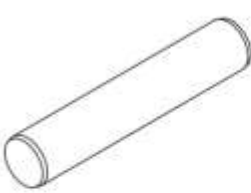

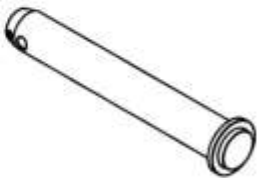
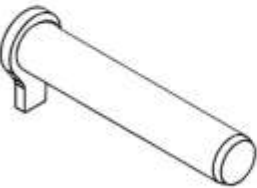



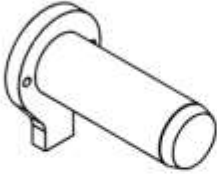
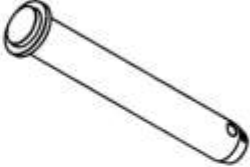





<p>BUCHA</p>  <p>22B7023670</p>	<p>BUCHA</p>  <p>22B7023680</p>	<p>BUCHA</p>  <p>23B7031730</p>	<p>BUCHA</p>  <p>13001B1550</p>
<p>BUCHA</p>  <p>13032B1130</p>	<p>BUCHA</p>  <p>13032B1140</p>	<p>BUCHA</p>  <p>13050B1110</p>	<p>BUCHA</p>  <p>13070B1120</p>
<p>BUCHA</p>  <p>13F5031131</p>	<p>BUCHA</p>  <p>20G7011380</p>	<p>BUCHA</p>  <p>12H7211380</p>	<p>BUCHA</p>  <p>21K01B1620</p>
<p>BUCHA</p>  <p>21K01B1621</p>	<p>BUCHA</p>  <p>21K7012161</p>	<p>BUCHA</p>  <p>21K7012170</p>	<p>BUCHA</p>  <p>21K7013150</p>
<p>BUCHA</p>  <p>21K7022130</p>	<p>BUCHA</p>  <p>21K7022250</p>	<p>BUCHA</p>  <p>21K7023130</p>	<p>BUCHA</p>  <p>21K7023150</p>



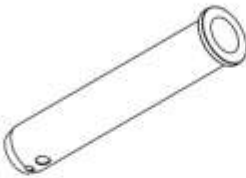





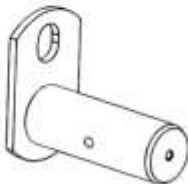

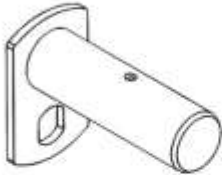

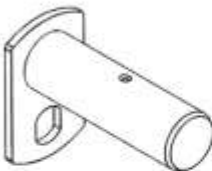
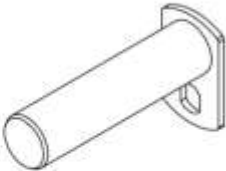
<p>BUCHA</p>  <p>21K7031390</p>	<p>BUCHA</p>  <p>21K7032120</p>	<p>BUCHA</p>  <p>21K7072211</p>	<p>BUCHA</p>  <p>21K7072230</p>
<p>BUCHA</p>  <p>21K7072240</p>	<p>BUCHA</p>  <p>21K7074210</p>	<p>BUCHA</p>  <p>21K7074220</p>	<p>BUCHA</p>  <p>12Y7212281</p>
<p>BUCHA</p>  <p>20Y3211141</p>	<p>BUCHA</p>  <p>20Y7021640</p>	<p>BUCHA</p>  <p>20Y7032361</p>	<p>BUCHA</p>  <p>20Y7032371</p>
<p>BUCHA</p>  <p>20Y7032410</p>	<p>PLACA</p>  <p>2057074391</p>	<p>PLACA</p>  <p>2077034240</p>	<p>PLACA</p>  <p>21K7023170</p>
<p>ROLETE</p>  <p>1701011460</p>	<p>PINO</p>  <p>4691566</p>	<p>PINO</p>  <p>0924150140</p>	<p>PINO</p>  <p>0924150160</p>

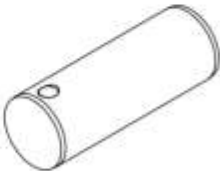

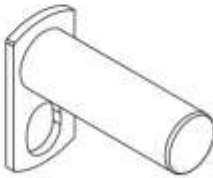
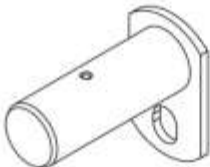

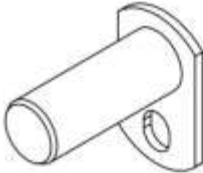

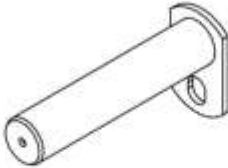
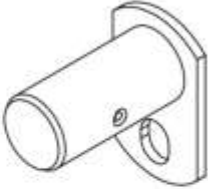
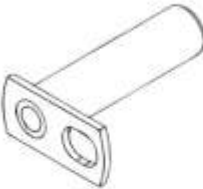
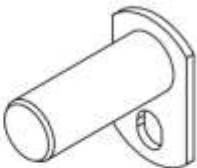
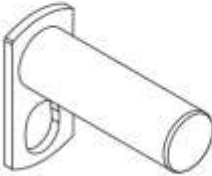
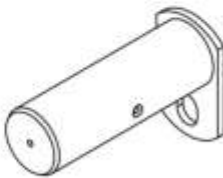
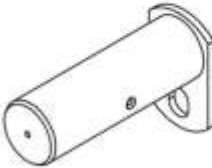



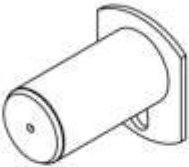

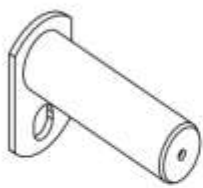
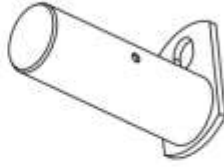
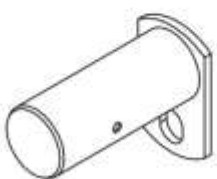
<p>PINO</p>  <p>1127011190</p>	<p>PINO</p>  <p>1207021210</p>	<p>PINO</p>  <p>1207039170</p>	<p>PINO</p>  <p>1241501010</p>
<p>PINO</p>  <p>1241552510</p>	<p>PINO</p>  <p>1243051180</p>	<p>PINO</p>  <p>1247251540</p>	<p>PINO</p>  <p>1247251660</p>
<p>PINO</p>  <p>1247251770</p>	<p>PINO</p>  <p>1247251790</p>	<p>PINO</p>  <p>1267051450</p>	<p>PINO</p>  <p>1304351271</p>
<p>PINO</p>  <p>1301443270</p>	<p>PINO</p>  <p>1307012111</p>	<p>PINO</p>  <p>1307012221</p>	<p>PINO</p>  <p>1307012190</p>
<p>PINO</p>  <p>1307041120</p>	<p>PINO</p>  <p>1307831140</p>	<p>PINO</p>  <p>1307831150</p>	<p>PINO</p>  <p>1311041450</p>

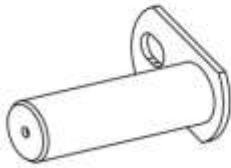
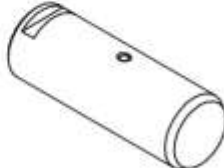
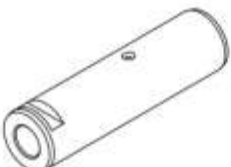

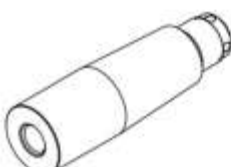

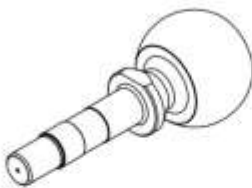

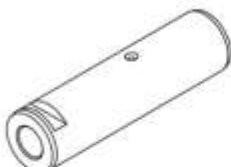
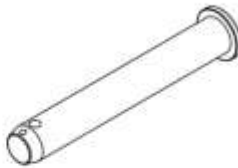

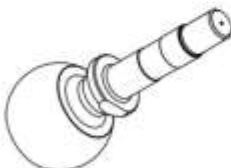
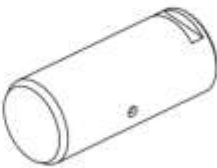

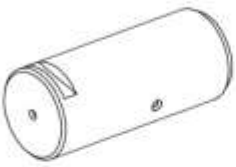
<p>PINO</p>  <p>1311442630</p>	<p>PINO</p>  <p>1311443260</p>	<p>PINO</p>  <p>1313044130</p>	<p>PINO</p>  <p>1317831221</p>
<p>PINO</p>  <p>1317831231</p>	<p>PINO</p>  <p>1317831250</p>	<p>PINO</p>  <p>1317831270</p>	<p>PINO</p>  <p>1345042161</p>
<p>PINO</p>  <p>1345050121</p>	<p>PINO</p>  <p>1345062121</p>	<p>PINO</p>  <p>1345062131</p>	<p>PINO</p>  <p>1347261331</p>
<p>PINO</p>  <p>1347261390</p>	<p>PINO</p>  <p>1347261510</p>	<p>PINO</p>  <p>1347261540</p>	<p>PINO</p>  <p>1353011230</p>
<p>PINO</p>  <p>1408037190</p>	<p>PINO</p>  <p>1409152110</p>	<p>PINO</p>  <p>1413031350</p>	<p>PINO</p>  <p>1441012730</p>

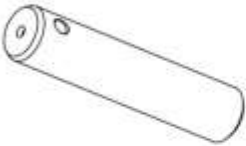
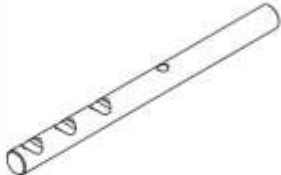
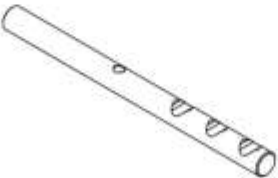
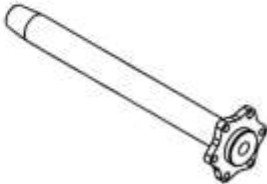
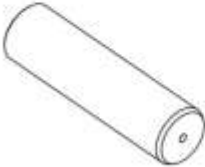
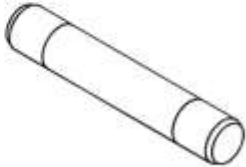

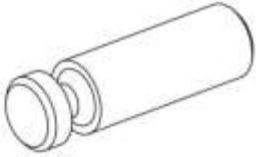

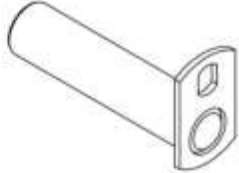
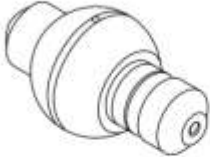
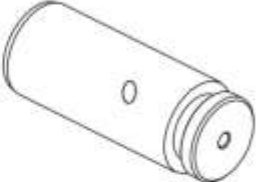
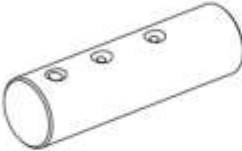
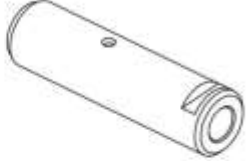
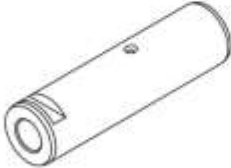





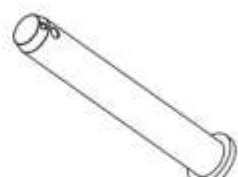
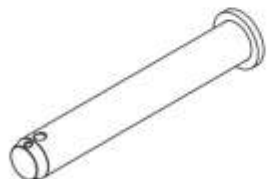

<p>PINO</p>  <p>1441522521</p>	<p>PINO</p>  <p>1441522530</p>	<p>PINO</p>  <p>1441522510</p>	<p>PINO</p>  <p>1447011160</p>
<p>PINO</p>  <p>1448171260</p>	<p>PINO</p>  <p>1448541280</p>	<p>PINO</p>  <p>1451542520</p>	<p>PINO</p>  <p>1451542530</p>
<p>PINO</p>  <p>1501011170</p>	<p>PINO</p>  <p>1547122470</p>	<p>PINO</p>  <p>2027061160</p>	<p>PINO</p>  <p>2027061180</p>
<p>PINO</p>  <p>2027064161</p>	<p>PINO</p>  <p>2027064163</p>	<p>PINO</p>  <p>2033261151</p>	<p>PINO</p>  <p>2033052141</p>
<p>PINO</p>  <p>2034656260</p>	<p>PINO</p>  <p>2037044380</p>	<p>PINO</p>  <p>2057065680</p>	<p>PINO</p>  <p>2057071190</p>

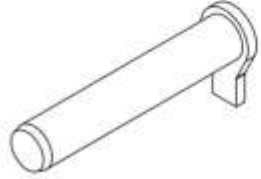

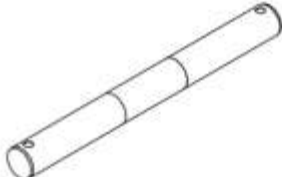
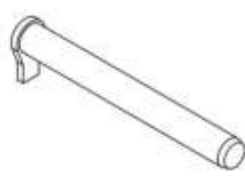
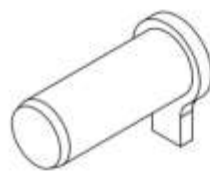
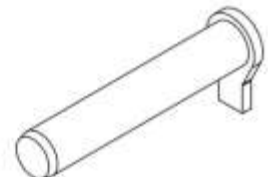
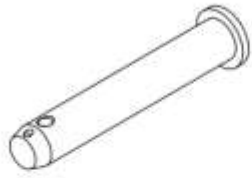
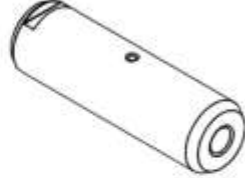

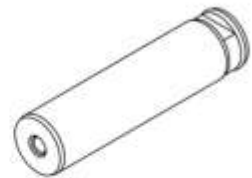

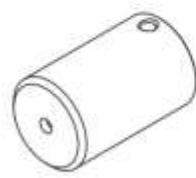



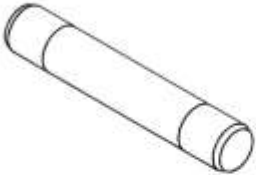



<p>PINO</p>  <p>2057071210</p>	<p>PINO</p>  <p>2057073160</p>	<p>PINO</p>  <p>2057073270</p>	<p>PINO</p>  <p>2067051190</p>
<p>PINO</p>  <p>2067053143</p>	<p>PINO</p>  <p>2067055160</p>	<p>PINO</p>  <p>2077031172</p>	<p>PINO</p>  <p>2077061210</p>
<p>PINO</p>  <p>2077061220</p>	<p>PINO</p>  <p>2077061230</p>	<p>PINO</p>  <p>2077071130</p>	<p>PINO</p>  <p>2077073210</p>
<p>PINO</p>  <p>2087033140</p>	<p>PINO</p>  <p>2087061210</p>	<p>PINO</p>  <p>2087061240</p>	<p>PINO</p>  <p>4172211410</p>
<p>PINO</p>  <p>4174611151</p>	<p>PINO</p>  <p>4174611240</p>	<p>PINO</p>  <p>4174632260</p>	<p>PINO</p>  <p>4176332220</p>

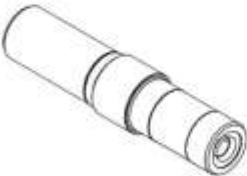

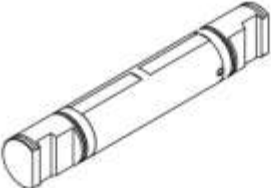
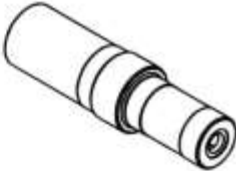
<p>PINO</p>  <p>4176332230</p>	<p>PINO</p>  <p>4177011590</p>	<p>PINO</p>  <p>4177031720</p>	<p>PINO</p>  <p>4177031740</p>
<p>PINO</p>  <p>4182211412</p>	<p>PINO</p>  <p>4182212510</p>	<p>PINO</p>  <p>4184611141</p>	<p>PINO</p>  <p>4187011720</p>
<p>PINO</p>  <p>4187011910</p>	<p>PINO</p>  <p>4187011921</p>	<p>PINO</p>  <p>4187011941</p>	<p>PINO</p>  <p>4187011950</p>
<p>PINO</p>  <p>4187011961</p>	<p>PINO</p>  <p>4187011972</p>	<p>PINO</p>  <p>4194612240</p>	<p>PINO</p>  <p>4194612260</p>
<p>PINO</p>  <p>4194632260</p>	<p>PINO</p>  <p>4197011790</p>	<p>PINO</p>  <p>4197011911</p>	<p>PINO</p>  <p>4197011922</p>

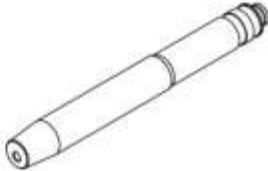
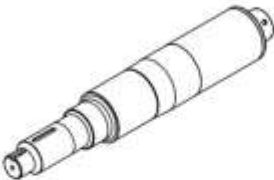
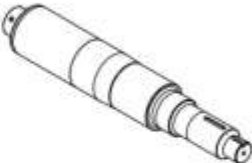
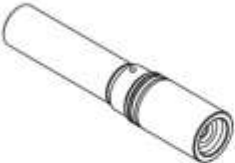
<p>PINO</p>  <p>4197011941</p>	<p>PINO</p>  <p>4197011950</p>	<p>PINO</p>  <p>4197011981</p>	<p>PINO</p>  <p>4197031220</p>
<p>PINO</p>  <p>4197031911</p>	<p>PINO</p>  <p>4197031920</p>	<p>PINO</p>  <p>4197031960</p>	<p>PINO</p>  <p>092415A140</p>
<p>PINO</p>  <p>092415A210</p>	<p>PINO</p>  <p>092415A230</p>	<p>PINO</p>  <p>23A2711310</p>	<p>PINO</p>  <p>23A2731520</p>
<p>PINO</p>  <p>23A2711199</p>	<p>PINO</p>  <p>23A2731350</p>	<p>PINO</p>  <p>092414B180</p>	<p>PINO</p>  <p>22B7012420</p>
<p>PINO</p>  <p>23B2711553</p>	<p>PINO</p>  <p>23B2731590</p>	<p>PINO</p>  <p>23B7031140</p>	<p>PINO</p>  <p>13001B1451</p>

<p>PINO</p>  <p>13001B1452</p>	<p>PINO</p>  <p>13010B1291</p>	<p>PINO</p>  <p>13010B2720</p>	<p>PINO</p>  <p>13014B1570</p>
<p>PINO</p>  <p>13014B1580</p>	<p>PINO</p>  <p>13030B1180</p>	<p>PINO</p>  <p>13030B2350</p>	<p>PINO</p>  <p>13032B5160</p>
<p>PINO</p>  <p>13070B1410</p>	<p>PINO</p>  <p>14410B5310</p>	<p>PINO</p>  <p>14478B5210</p>	<p>PINO</p>  <p>41770B3310</p>
<p>PINO</p>  <p>12F7241391</p>	<p>PINO</p>  <p>12F7241470</p>	<p>PINO</p>  <p>12G1552510</p>	<p>PINO</p>  <p>12H7211580</p>
<p>PINO</p>  <p>12H7211581</p>	<p>PINO</p>  <p>21K2631190</p>	<p>PINO</p>  <p>21K7011170</p>	<p>PINO</p>  <p>21K7012151</p>

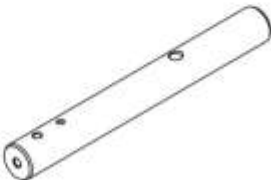



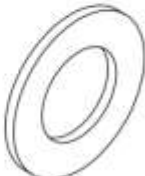







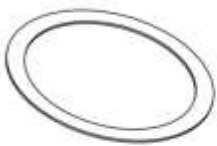

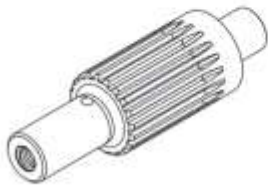
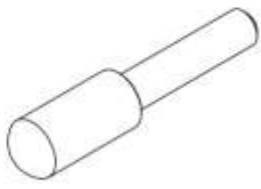

<p>PINO</p>  <p>21K7021170</p>	<p>PINO</p>  <p>21K7021180</p>	<p>PINO</p>  <p>21K7022120</p>	<p>PINO</p>  <p>21K7023140</p>
<p>PINO</p>  <p>21K7023190</p>	<p>PINO</p>  <p>21K7023220</p>	<p>PINO</p>  <p>21K7031170</p>	<p>PINO</p>  <p>21K7031310</p>
<p>PINO</p>  <p>21K7031360</p>	<p>PINO</p>  <p>21K7071160</p>	<p>PINO</p>  <p>21K7071170</p>	<p>PINO</p>  <p>21K7071180</p>
<p>PINO</p>  <p>22U7021191</p>	<p>PINO</p>  <p>14X7811310</p>	<p>PINO</p>  <p>12Y2711220</p>	<p>PINO</p>  <p>12Y7212231</p>
<p>PINO</p>  <p>12Y7212251</p>	<p>PINO</p>  <p>20Y2622250</p>	<p>PINO</p>  <p>20Y2721220</p>	<p>PINO</p>  <p>20Y2751220</p>

<p>PINO</p>  <p>20Y3211190</p>	<p>PINO</p>  <p>20Y7011180</p>	<p>EIXO</p>  <p>1243051141</p>	<p>EIXO</p>  <p>1243051142</p>
<p>EIXO</p>  <p>1243051143</p>	<p>EIXO</p>  <p>1243051181</p>	<p>EIXO</p>  <p>1243053120</p>	<p>EIXO</p>  <p>1311443251</p>
<p>EIXO</p>  <p>1313036130</p>	<p>EIXO</p>  <p>1343062220</p>	<p>EIXO</p>  <p>1343062241</p>	<p>EIXO</p>  <p>1343063142</p>
<p>EIXO</p>  <p>1352712211</p>	<p>EIXO</p>  <p>1352712410</p>	<p>EIXO</p>  <p>1353015110</p>	<p>EIXO</p>  <p>1413016111</p>
<p>EIXO</p>  <p>1413035120</p>	<p>EIXO</p>  <p>1413036130</p>	<p>EIXO</p>  <p>1411432175</p>	<p>EIXO</p>  <p>23A2711250</p>

<p>EIXO</p>  <p>23A2711251</p>	<p>EIXO</p>  <p>11230B1710</p>	<p>EIXO</p>  <p>13014B1560</p>	<p>EIXO</p>  <p>22U3011420</p>
<p>EIXO</p>  <p>20Y3013130</p>	<p>EIXO</p>  <p>20Y3016130</p>	<p>EIXO</p>  <p>20Y7041211</p>	<p>ARRUELA</p>  <p>1242252240</p>

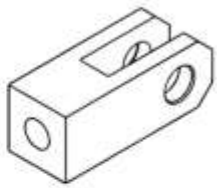
EMBREGEM PARA MÁQUINA KOMATSU D50

<p>TAMPA</p>  <p>13010B2130</p>	<p>BUCHA</p>  <p>13010B2170</p>	<p>FORQUETA</p>  <p>13010B2220</p>	<p>GARFO</p>  <p>13010B2860</p>
<p>CUBO</p>  <p>13010B2240</p>	<p>CUBO</p>  <p>13010B3340</p>	<p>HASTE</p>  <p>13010B3380</p>	<p>GARFO</p>  <p>1411013170</p>

<p>ARRUELA</p>  <p>13032B5180</p>	<p>ARRUELA</p>  <p>21P60K2850</p>	<p>ARRUELA</p>  <p>21P60K2860</p>	<p>REDENTOR</p>  <p>21P60K2730</p>
<p>PONTA DE EIXO</p>  <p>13010B3190P</p>	<p>ÊMBOLO</p>  <p>13014B1630</p>	<p>ÊMBOLO</p>  <p>13014B1650</p>	<p>JUNÇÃO</p>  <p>1207039160</p>
<p>JUNÇÃO</p>  <p>1307012131</p>	<p>JUNÇÃO</p>  <p>1447012130</p>	<p>ESPAÇADOR</p>  <p>1353211381</p>	<p>ESPAÇADOR</p>  <p>1443211180</p>
<p>ENGRENAGEM</p>  <p>CA0128714</p>	<p>ENGATE</p>  <p>13010B1360</p>	<p>GRUPOS PARA ESTEIRAS</p>  <p>GR D41E CR GR D50 CR GR D65 CR</p>	
<p>GRUPOS PARA ESTEIRAS</p>  <p>GR D30 45 GR D30 47 GR D155 GR D41A GR D41E GR D50 CV GR D50 P GR D50 SV GR D51 GR D60</p>		<p>GR D65 GR PC138 GR PC150/3 GR PC150/5 GR PC160 GR PC200 GR PC220 GR PC240 GR PC300</p>	<p>HASTE</p>  <p>13010B2230</p>

<p>BUCHA</p>  <p>3688384M1</p>	<p>PORCA</p>  <p>6612415</p>	<p>CARÇA DE ARTICULAÇÃO</p>  <p>6612125 LD</p>	<p>CARÇA DE ARTICULAÇÃO</p>  <p>6612126 LE</p>
<p>PORTADOR PLANETÁRIO</p>  <p>6612127</p>	<p>ENGRENAGEM</p>  <p>3665711</p>		

<p>EIXO</p>  <p>60A0384</p>	<p>EIXO</p>  <p>60A0398</p>	<p>EIXO</p>  <p>60A0830</p>
--	--	---

PORCA



42854199

PORTADOR PLANETÁRIO



42854210

PORCA































MZ0806002100B98



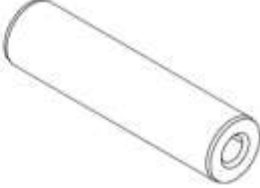







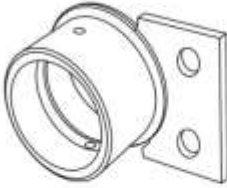









PORTADOR PLANETARIO











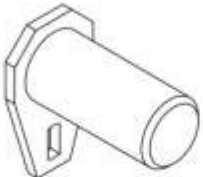

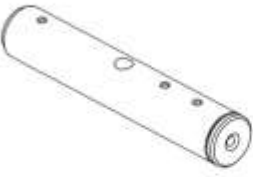



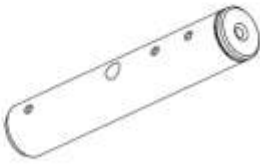
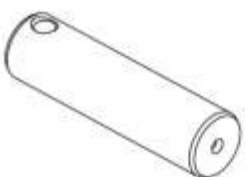
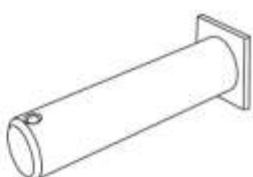

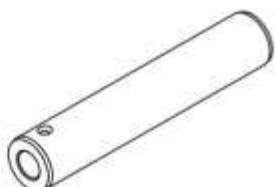
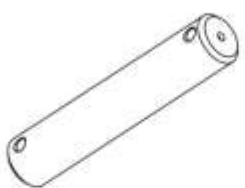

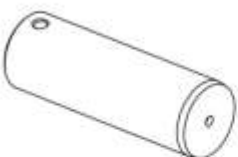

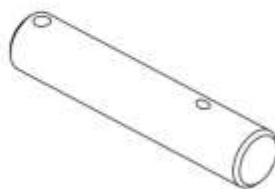
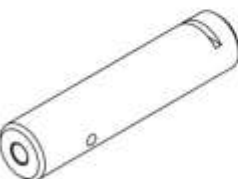
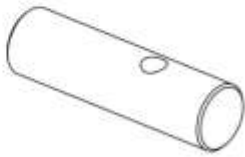



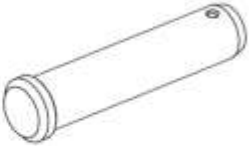
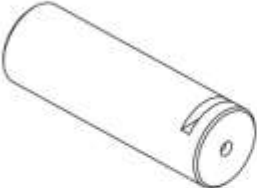

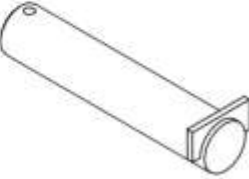
MZ0806002100C09



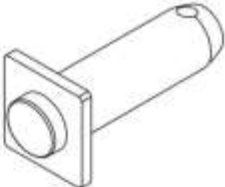
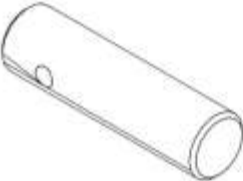
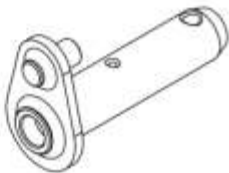



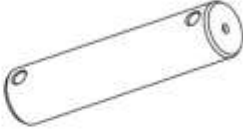
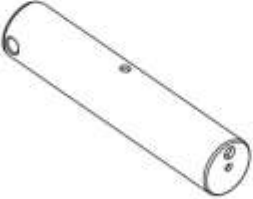
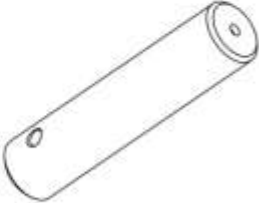



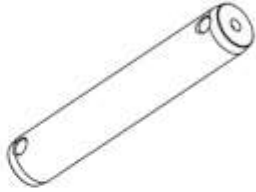

<p>BUCHA</p>  <p>024206</p>	<p>BUCHA</p>  <p>024209</p>	<p>BUCHA</p>  <p>024210</p>	<p>BUCHA</p>  <p>028925</p>
<p>BUCHA</p>  <p>034230</p>	<p>BUCHA</p>  <p>036582</p>	<p>BUCHA</p>  <p>037919</p>	<p>BUCHA</p>  <p>041614</p>
<p>BUCHA</p>  <p>061224</p>	<p>BUCHA</p>  <p>862589</p>	<p>BUCHA</p>  <p>862627</p>	<p>BUCHA</p>  <p>862691</p>
<p>BUCHA</p>  <p>863147</p>	<p>BUCHA</p>  <p>871315</p>	<p>BUCHA</p>  <p>871318</p>	<p>BUCHA</p>  <p>871352</p>
<p>BUCHA</p>  <p>871353</p>	<p>BUCHA</p>  <p>871417</p>	<p>BUCHA</p>  <p>871705</p>	<p>BUCHA</p>  <p>871710</p>

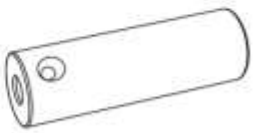

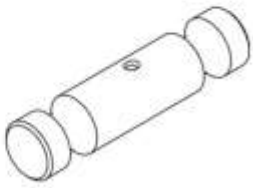
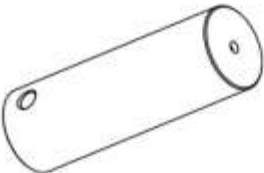
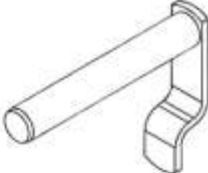

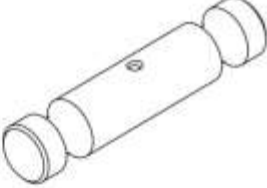

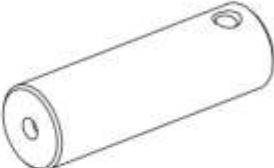
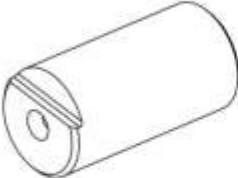
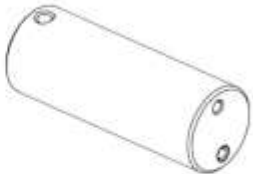
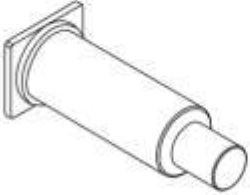
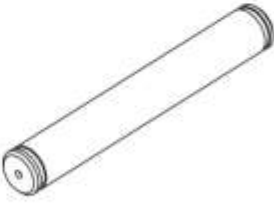

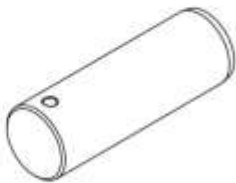

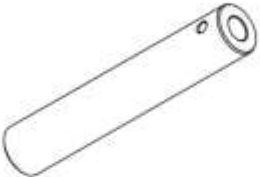

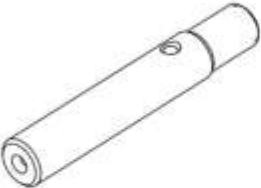

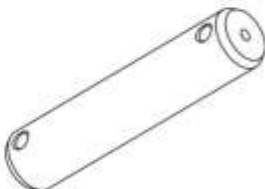
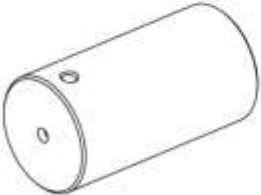
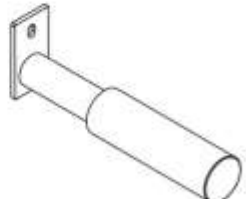
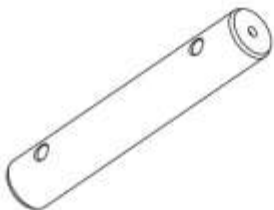
<p>BUCHA</p>  <p>874620</p>	<p>BUCHA</p>  <p>981443</p>	<p>BUCHA</p>  <p>1661065</p>	<p>BUCHA</p>  <p>2710881</p>
<p>BUCHA</p>  <p>2710883</p>	<p>BUCHA</p>  <p>2710891</p>	<p>BUCHA</p>  <p>2750610</p>	<p>BUCHA</p>  <p>2752109</p>
<p>BUCHA</p>  <p>2757609</p>	<p>BUCHA</p>  <p>2757721</p>	<p>BUCHA</p>  <p>2803248</p>	<p>BUCHA</p>  <p>3098416</p>
<p>BUCHA</p>  <p>3147278</p>	<p>BUCHA</p>  <p>3147301</p>	<p>BUCHA</p>  <p>3147313</p>	<p>BUCHA</p>  <p>3149143</p>
<p>BUCHA</p>  <p>3175777</p>	<p>BUCHA</p>  <p>3175831</p>	<p>BUCHA</p>  <p>3408498</p>	<p>BUCHA</p>  <p>3409139</p>

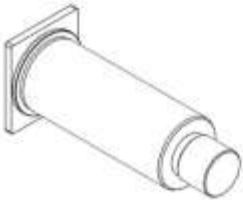



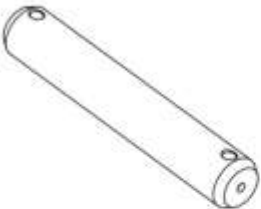

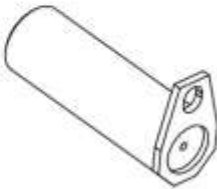

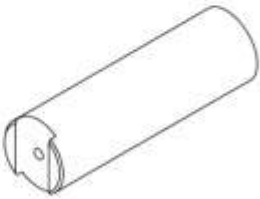

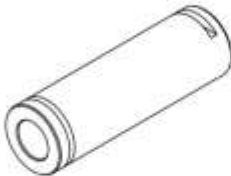
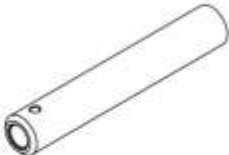

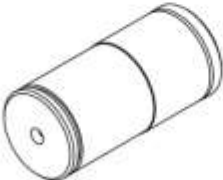
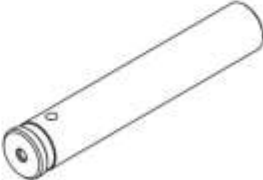
<p>BUCHA</p>  <p>3411856</p>	<p>BUCHA</p>  <p>3411868</p>	<p>BUCHA</p>  <p>3411872</p>	<p>BUCHA</p>  <p>3500009</p>
<p>BUCHA</p>  <p>3500047</p>	<p>BUCHA</p>  <p>3501015</p>	<p>BUCHA</p>  <p>3501770</p>	<p>BUCHA</p>  <p>3587902</p>
<p>BUCHA</p>  <p>3588880</p>	<p>BUCHA</p>  <p>036375R1</p>	<p>BUCHA</p>  <p>040942R1</p>	<p>BUCHA</p>  <p>040953R1</p>
<p>BUCHA</p>  <p>040954R1</p>	<p>BUCHA</p>  <p>040957R1</p>	<p>BUCHA</p>  <p>040968R1</p>	<p>BUCHA</p>  <p>053951R1</p>
<p>BUCHA</p>  <p>3907155M1</p>	<p>BUCHA</p>  <p>6204504M1</p>	<p>BUCHA</p>  <p>6210006M1</p>	<p>RÓTULA</p>  <p>040949R1</p>

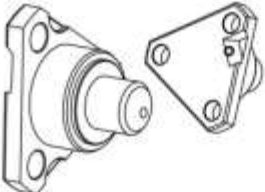







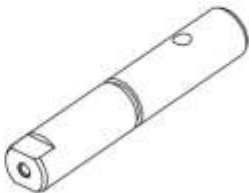



<p>PINO</p>  <p>024000</p>	<p>PINO</p>  <p>024192</p>	<p>PINO</p>  <p>024204</p>	<p>PINO</p>  <p>024419</p>
<p>PINO</p>  <p>024425</p>	<p>PINO</p>  <p>024429</p>	<p>PINO</p>  <p>033991</p>	<p>PINO</p>  <p>034229</p>
<p>PINO</p>  <p>036452</p>	<p>PINO</p>  <p>036799</p>	<p>PINO</p>  <p>040208</p>	<p>PINO</p>  <p>042735</p>
<p>PINO</p>  <p>042765</p>	<p>PINO</p>  <p>043698</p>	<p>PINO</p>  <p>043716</p>	<p>PINO</p>  <p>058456</p>
<p>PINO</p>  <p>180413</p>	<p>PINO</p>  <p>180444</p>	<p>PINO</p>  <p>180445</p>	<p>PINO</p>  <p>180449</p>

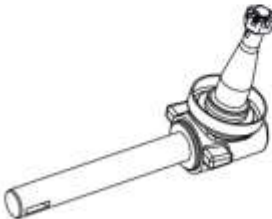



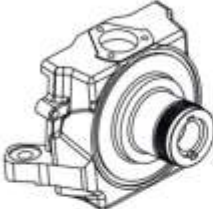
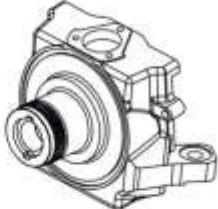

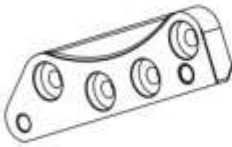













<p>PINO</p>  <p>191211</p>	<p>PINO</p>  <p>364231</p>	<p>PINO</p>  <p>516390</p>	<p>PINO</p>  <p>729210</p>
<p>PINO</p>  <p>824996</p>	<p>PINO</p>  <p>862617</p>	<p>PINO</p>  <p>862620</p>	<p>PINO</p>  <p>862661</p>
<p>PINO</p>  <p>862663</p>	<p>PINO</p>  <p>862665</p>	<p>PINO</p>  <p>862672</p>	<p>PINO</p>  <p>862967</p>
<p>PINO</p>  <p>863064</p>	<p>PINO</p>  <p>871454</p>	<p>PINO</p>  <p>871455</p>	<p>PINO</p>  <p>871456</p>
<p>PINO</p>  <p>871458</p>	<p>PINO</p>  <p>871459</p>	<p>PINO</p>  <p>871460</p>	<p>PINO</p>  <p>871462</p>

<p>PINO</p>  <p>871466</p>	<p>PINO</p>  <p>871468</p>	<p>PINO</p>  <p>871729</p>	<p>PINO</p>  <p>871792</p>
<p>PINO</p>  <p>874792</p>	<p>PINO</p>  <p>894799</p>	<p>PINO</p>  <p>898016</p>	<p>PINO</p>  <p>898363</p>
<p>PINO</p>  <p>981444</p>	<p>PINO</p>  <p>1458757</p>	<p>PINO</p>  <p>1484073</p>	<p>PINO</p>  <p>1488476</p>
<p>PINO</p>  <p>1684285</p>	<p>PINO</p>  <p>1864869</p>	<p>PINO</p>  <p>1866538</p>	<p>PINO</p>  <p>2750504</p>
<p>PINO</p>  <p>2750597</p>	<p>PINO</p>  <p>2757734</p>	<p>PINO</p>  <p>2757953</p>	<p>PINO</p>  <p>2760504</p>

<p>PINO</p>  <p>2800731</p>	<p>PINO</p>  <p>2800906</p>	<p>PINO</p>  <p>3148787</p>	<p>PINO</p>  <p>3175453</p>
<p>PINO</p>  <p>32731127</p>	<p>PINO</p>  <p>3408490</p>	<p>PINO</p>  <p>3409001</p>	<p>PINO</p>  <p>3409652</p>
<p>PINO</p>  <p>3411479</p>	<p>PINO</p>  <p>3411480</p>	<p>PINO</p>  <p>3411873</p>	<p>PINO</p>  <p>3500034</p>
<p>PINO</p>  <p>3500035</p>	<p>PINO</p>  <p>3500036</p>	<p>PINO</p>  <p>3500037</p>	<p>PINO</p>  <p>3500046</p>
<p>PINO</p>  <p>3501769</p>	<p>PINO</p>  <p>3511550</p>	<p>PINO</p>  <p>3587841</p>	<p>PINO</p>  <p>3587846</p>

<p>PINO</p>  <p>020955P1</p>	<p>PINO</p>  <p>042735P1</p>	<p>PINO</p>  <p>043928R1</p>	<p>PINO</p>  <p>061237R1/C</p>
<p>PINO</p>  <p>061237R1/P</p>	<p>PINO</p>  <p>898016M3</p>	<p>PIVÓ (FORJADO)</p>  <p>043132R1</p>	<p>PIVÓ (FORJADO)</p>  <p>3176321M1</p>
<p>PIVÓ (FORJADO)</p>  <p>033725R1</p>	<p>PIVÓ (FORJADO)</p>  <p>061296R1</p>	<p>PIVÓ (FORJADO)</p>  <p>061297R1</p>	<p>EIXO</p>  <p>058424</p>
<p>EIXO</p>  <p>184359</p>	<p>EIXO</p>  <p>897567</p>	<p>EIXO</p>  <p>1481169</p>	<p>EIXO</p>  <p>1481516</p>
<p>EIXO</p>  <p>1676665</p>	<p>EIXO</p>  <p>1676666</p>	<p>EIXO</p>  <p>3409164</p>	<p>EIXO</p>  <p>3409165</p>

<p>EIXO</p>  <p>1488394M3</p>	<p>EIXO</p>  <p>033075P1</p>	<p>EIXO</p>  <p>033076P1</p>	<p>FLANGE</p>  <p>881156</p>																												
<p>MANGAS DE EIXO</p>  <table border="1" data-bbox="461 613 695 872"> <tr><td>1481635</td><td>487989</td></tr> <tr><td>1481636</td><td>487990</td></tr> <tr><td>1481873</td><td>489027</td></tr> <tr><td>1481874</td><td>489030</td></tr> <tr><td>2802521</td><td>489314</td></tr> <tr><td>2802526</td><td>489315</td></tr> <tr><td>3146770</td><td>489703</td></tr> <tr><td>3146771</td><td>489705</td></tr> </table>		1481635	487989	1481636	487990	1481873	489027	1481874	489030	2802521	489314	2802526	489315	3146770	489703	3146771	489705	<p>MANGAS DE EIXO</p>  <table border="1" data-bbox="1102 634 1303 851"> <tr><td>037461</td><td>1481392</td></tr> <tr><td>037462</td><td>1481393</td></tr> <tr><td>037463</td><td>1481397</td></tr> <tr><td>037464</td><td>1481398</td></tr> <tr><td>487207</td><td>2801790</td></tr> <tr><td>487208</td><td>2801791</td></tr> </table>		037461	1481392	037462	1481393	037463	1481397	037464	1481398	487207	2801790	487208	2801791
1481635	487989																														
1481636	487990																														
1481873	489027																														
1481874	489030																														
2802521	489314																														
2802526	489315																														
3146770	489703																														
3146771	489705																														
037461	1481392																														
037462	1481393																														
037463	1481397																														
037464	1481398																														
487207	2801790																														
487208	2801791																														
<p>HASTES</p>  <table border="1" data-bbox="419 959 711 1197"> <tr><td>1 1/2 x 13</td><td>1 1/2 x 471</td></tr> <tr><td>1 1/2 x 280</td><td>1 1/4 x 13</td></tr> <tr><td>1 1/2 x 295</td><td>1 1/4 x 14 1/2</td></tr> <tr><td>1 1/2 x 320</td><td>1 1/4 x 280</td></tr> <tr><td>1 1/2 x 390</td><td>1 1/4 x 342</td></tr> <tr><td>1 1/2 x 450</td><td>1 1/4 x 370</td></tr> <tr><td>1 1/2 x 460</td><td>1 1/4 x 500</td></tr> <tr><td>1 1/2 x 468</td><td></td></tr> </table>		1 1/2 x 13	1 1/2 x 471	1 1/2 x 280	1 1/4 x 13	1 1/2 x 295	1 1/4 x 14 1/2	1 1/2 x 320	1 1/4 x 280	1 1/2 x 390	1 1/4 x 342	1 1/2 x 450	1 1/4 x 370	1 1/2 x 460	1 1/4 x 500	1 1/2 x 468		<p>MANGAS DE EIXO</p>  <table border="1" data-bbox="1059 1021 1316 1127"> <tr><td>3145066</td><td>3149077</td></tr> <tr><td>3145067</td><td>3317634</td></tr> <tr><td>3149076</td><td>3317635</td></tr> </table>		3145066	3149077	3145067	3317634	3149076	3317635						
1 1/2 x 13	1 1/2 x 471																														
1 1/2 x 280	1 1/4 x 13																														
1 1/2 x 295	1 1/4 x 14 1/2																														
1 1/2 x 320	1 1/4 x 280																														
1 1/2 x 390	1 1/4 x 342																														
1 1/2 x 450	1 1/4 x 370																														
1 1/2 x 460	1 1/4 x 500																														
1 1/2 x 468																															
3145066	3149077																														
3145067	3317634																														
3149076	3317635																														
<p>MANGA DE EIXO</p>  <p>6303370M91 LE</p>	<p>MANGA DE EIXO</p>  <p>6304746M91 LD</p>	<p>CARÇA DE ARTICULAÇÃO</p>  <p>048301R1 LE</p>	<p>CARÇA DE ARTICULAÇÃO</p>  <p>048360R1 LD</p>																												
<p>CARÇA DE ARTICULAÇÃO</p>  <p>33554R1 LE</p>	<p>CARÇA DE ARTICULAÇÃO</p>  <p>33555R1 LD</p>	<p>PLACA</p>  <p>1484687</p>	<p>PORTADOR PLANETÁRIO</p>  <p>048347R1</p>																												

<p>PORTA PLANETÁRIO</p>  <p>061237R1</p>	<p>PORTADOR PLANETÁRIO</p>  <p>3176339M1</p>	<p>PORTADOR PLANETÁRIO</p>  <p>3603350M1</p>	<p>CUBO</p>  <p>020811R1</p>
<p>CUBO</p>  <p>061242R1</p>	<p>CUBO</p>  <p>1860890</p>	<p>PORCA</p>  <p>3176334M1</p>	<p>PORCA</p>  <p>33621R1</p>
<p>PORCA</p>  <p>0737503040</p>	<p>ARRUELA</p>  <p>898017</p>	<p>ARRUELA</p>  <p>898018</p>	<p>ARRUELA</p>  <p>898019</p>
<p>ARRUELA</p>  <p>6203409</p>	<p>ARRUELA</p>  <p>036374R1</p>	<p>ARRUELA</p>  <p>040966R1</p>	<p>ARRUELA</p>  <p>040967R1</p>
<p>HASTE</p>  <p>1754643</p>	<p>ENGRENAGEM</p>  <p>3785488M1</p>	<p>ENGRENAGEM</p>  <p>061274R1</p>	<p>ENGRENAGEM</p>  <p>062390R1</p>

<p>HASTE</p>  <p>1754644</p>	<p>HASTE</p>  <p>2730372</p>	<p>HASTE</p>  <p>FRESADA P FRESADA M FRESADA G</p>	<p>BRAÇO DA DIREÇÃO</p>  <p>3147527</p>
<p>BRAÇO DA DIREÇÃO</p>  <p>3147528</p>			

CONJUNTO CARÇA DE ARTICULAÇÃO PARA MÁQUINAS MASSEY FERGUSON

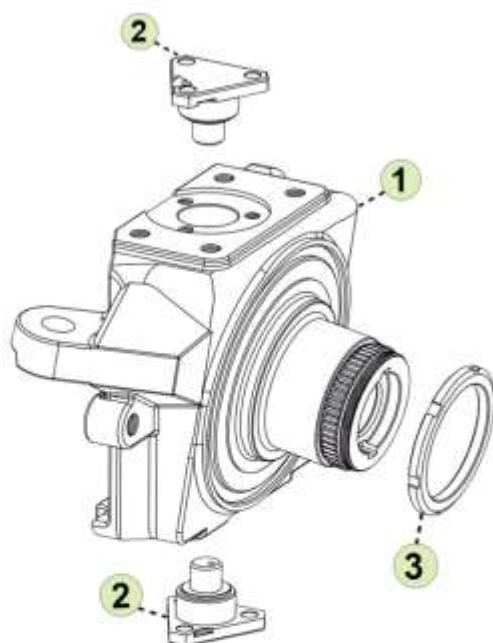

CARÇA DE ARTICULAÇÃO

33554R1 LE
33555R1 LD
048301R1 LE
048360R1 LD

PIVÔ

31763221M1

PORCA

3176334M1

ACOMPANHA

POS.	QTD.	DESCRIÇÃO
1	01	Carça de Articulação
2	02	Pinos Pivô
3	01	Porca

KIT - 65R DIANTEIRO (KT MF65R D)

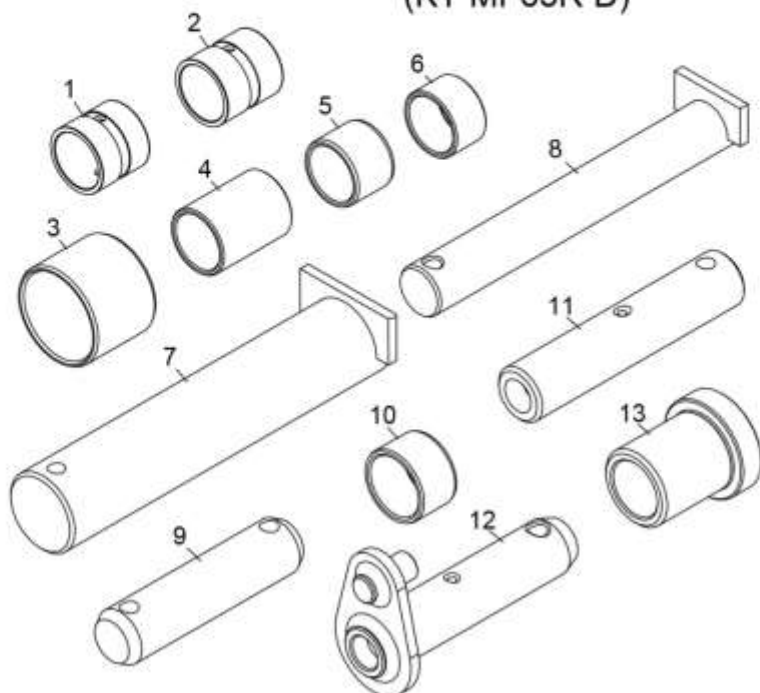

POS.	CÓDIGO
1	2710881
2	2710891
3	862691
4	863147
5	3147313M1
6	862627
7	862617
8	862620
9	862663
10	2710883M1
11	862661
12	862967
13	862589

KIT - 65R TRASEIRO (KT MF65R T)

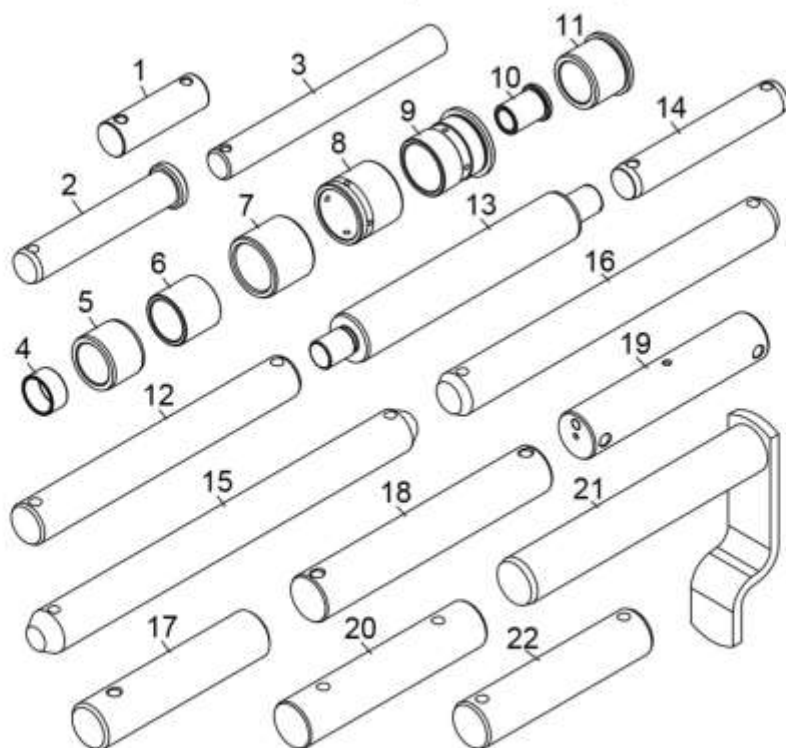

POS.	CÓDIGO
1	824996
2	871462M91
3	871468
4	871417
5	871353
6	871710
7	874620
8	871352
9	871315
10	871318
11	871705M1
12	871455
13	871453
14	871792
15	871729
16	871454
17	871459
18	1484073
19	871458
20	871460
21	1458757
22	871456

KIT - 86 DIANTEIRO (KT MF86 D)

POS.	CODIGO
1	2710881
2	2710891
3	862691
4	863147
5	3147313
6	862627
7	862617
8	862620
9	862663
10	2710883
11	862661
12	862967
13	862589

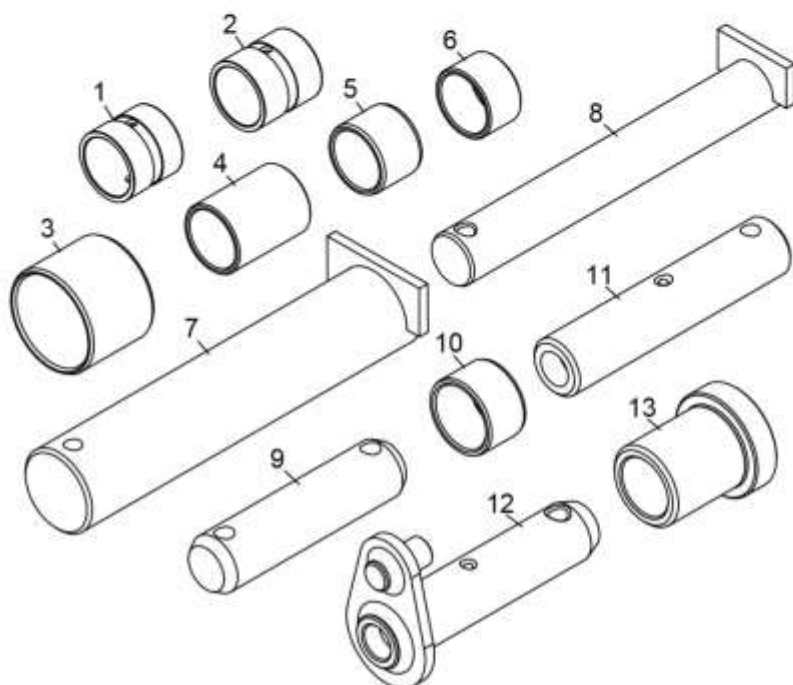

KIT - 86 EIXO DIREÇÃO (KT MF86 E)

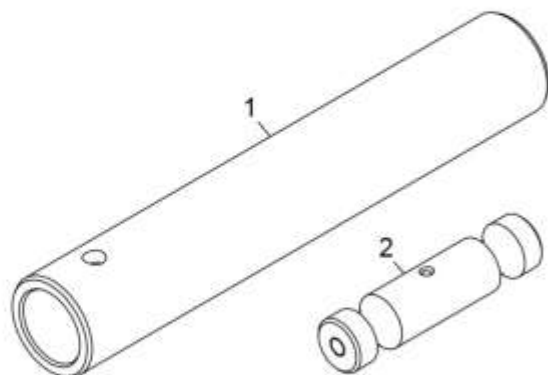

POS.	CÓDIGO
1	1684285
2	898363

KIT - 86 TRASEIRO HS (KT MF86 T HS)

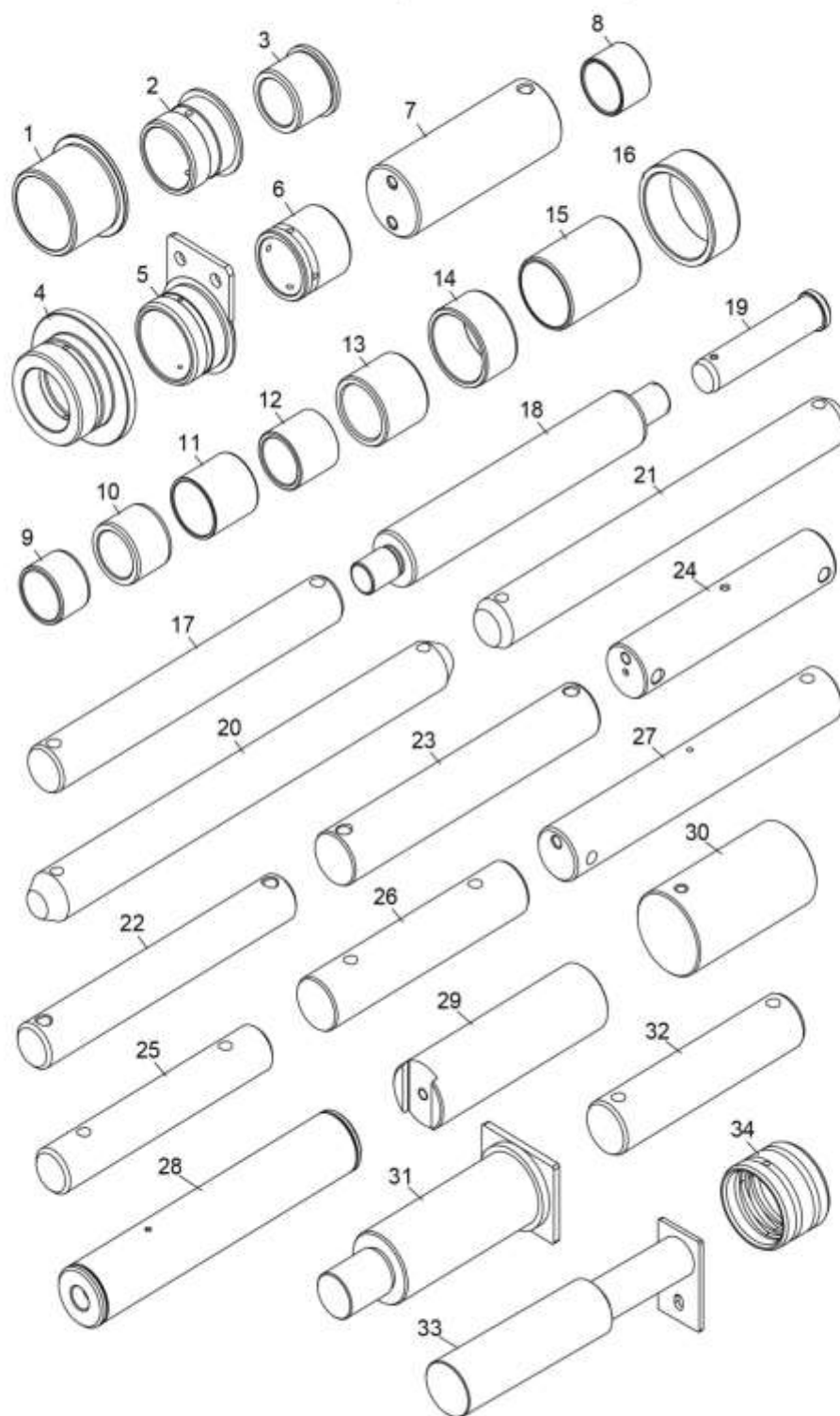

POS.	CÓDIGO
1	3411872
2	3500047
3	871705
4	3411868
5	3587902
6	871352
7	2750504
8	3147278
9	3175777
10	871353
11	3149143
12	871710
13	874620
14	3175831
15	3588880
16	3409139
17	871455
18	871453
19	364231
20	871729
21	871454
22	3411480
23	1484073
24	871458
25	3411479
26	871460
27	3411146
28	3587841
29	3587846
30	3409001
31	2750597
32	871456
33	3409652
34	2757721

KIT - 86 TRASEIRO (KT MF86 T)

POS.	CÓDIGO
1	3411872
2	3500047
3	871705
4	3411868
5	3587902
6	871352
7	2750504
8	3147278
9	3175777M1
10	871353
11	3149143
12	871710
13	874620
14	3175831M1
15	3588880
16	3409139M1
17	871455
18	871453
19	364231
20	871729
21	871454
22	3411480
23	1484073
24	871458
25	3411479
26	871460
27	3411146
28	3587841
29	3587846
30	3409001
31	2750597
32	871456
33	2757721

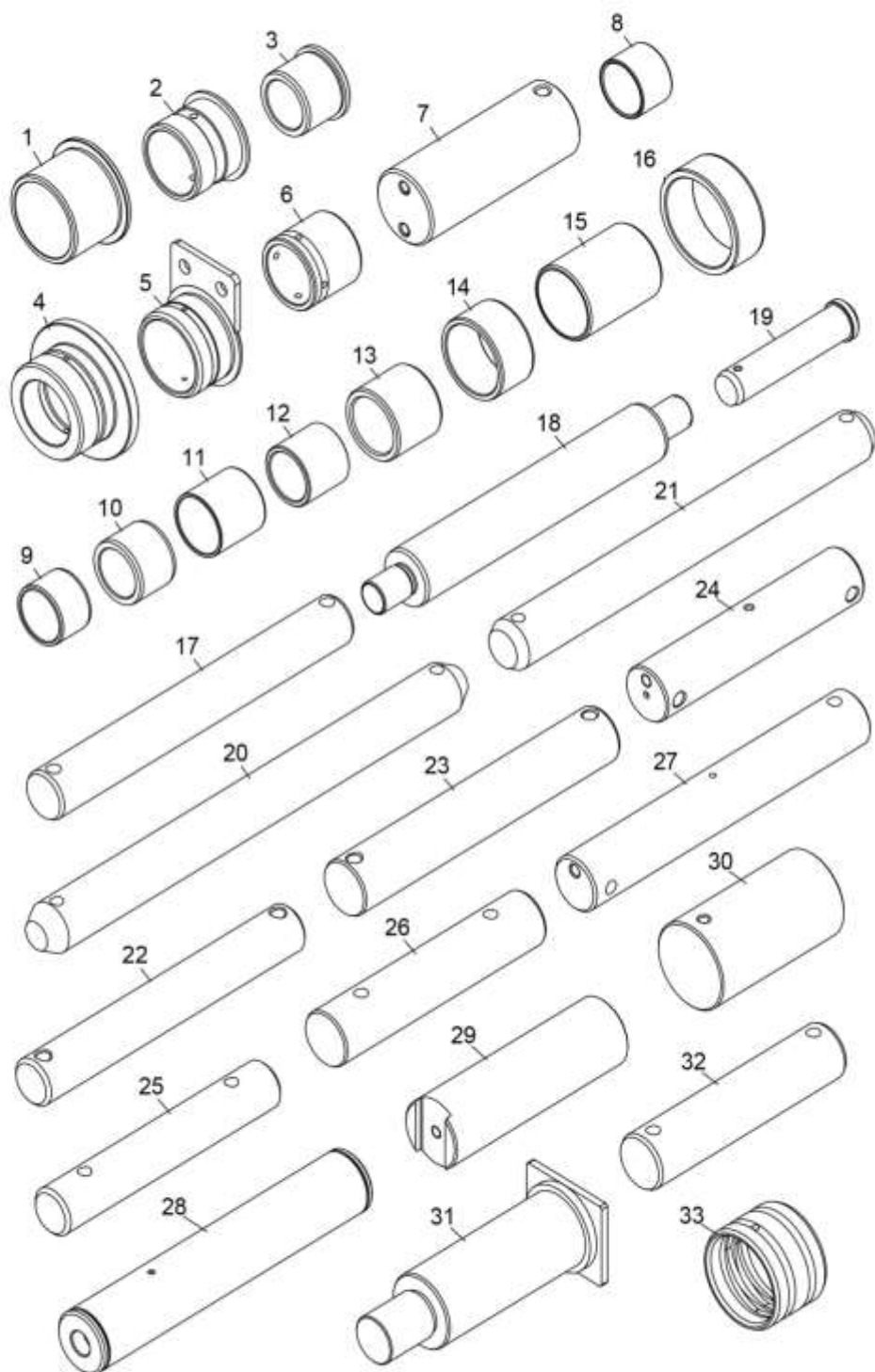

KIT - 96 TRASEIRO FASE 2 (KT MF96 T FASE 2)

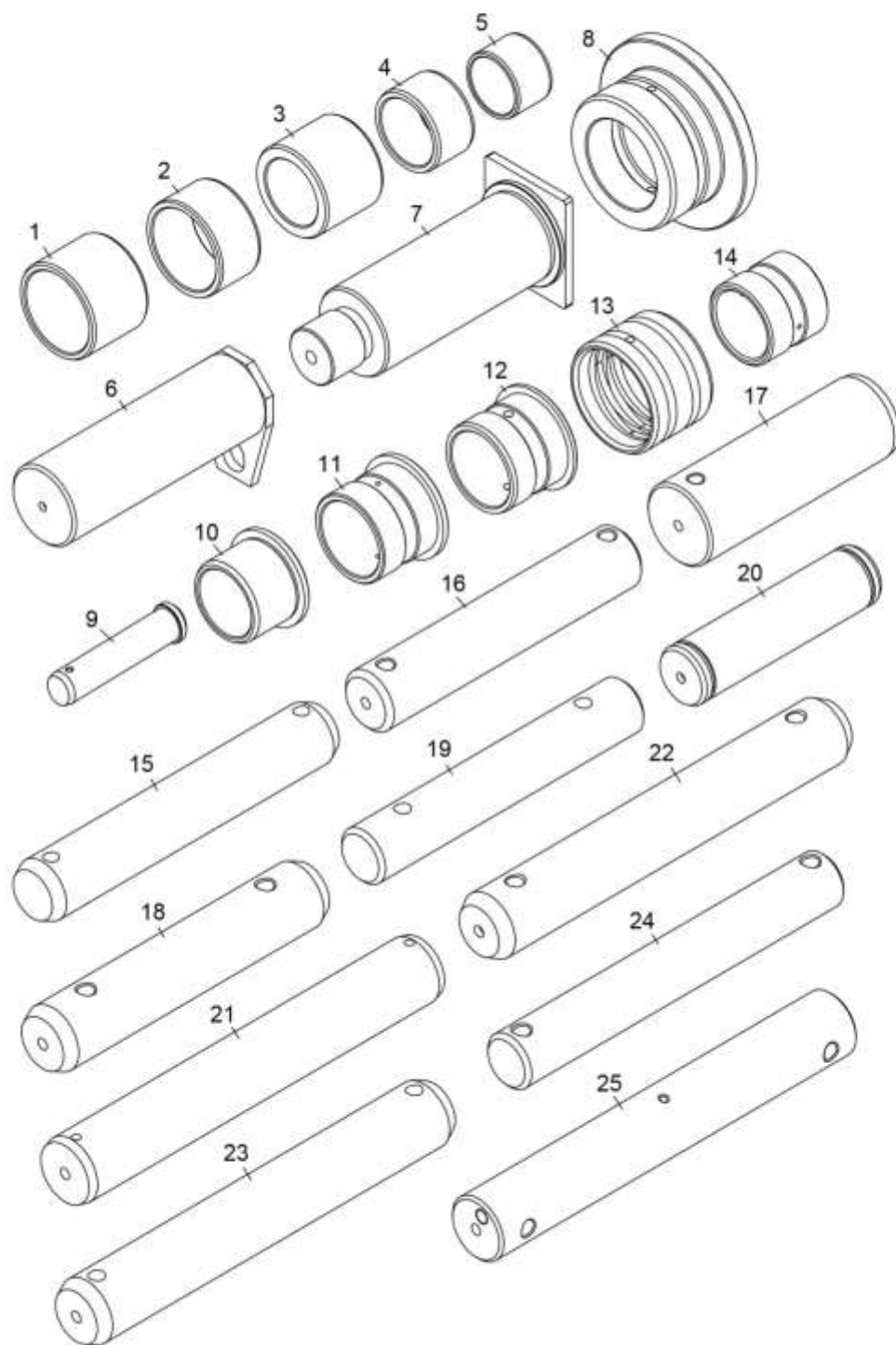

POS.	CÓDIGO
1	037919
2	3175831
3	028925
4	042651
5	3175777
6	3511550
7	3411873
8	3411868
9	364231
10	3501770
11	3501015
12	3500047
13	2757721
14	3500009
15	3500037
16	042765
17	043716
18	3500036
19	3411479
20	3500046
21	3501769
22	3500035
23	3500034
24	3411480
25	043698

KIT - 96 TRASEIRO FASE 2 4X4 (KT MF96 T FASE 2 4X4)

POS.	CÓDIGO
1	028925
2	037919
3	042651
4	042765
5	043698
6	043716
7	2757721
8	3175777
9	3175831
10	3411479
11	3411480
12	3411868
13	3411873
14	3500009
15	3500034
16	3500035
17	3500036
18	3500037
19	3500046
20	3500047
21	3501015
22	3501769
23	3501770
24	3511550
25	364231

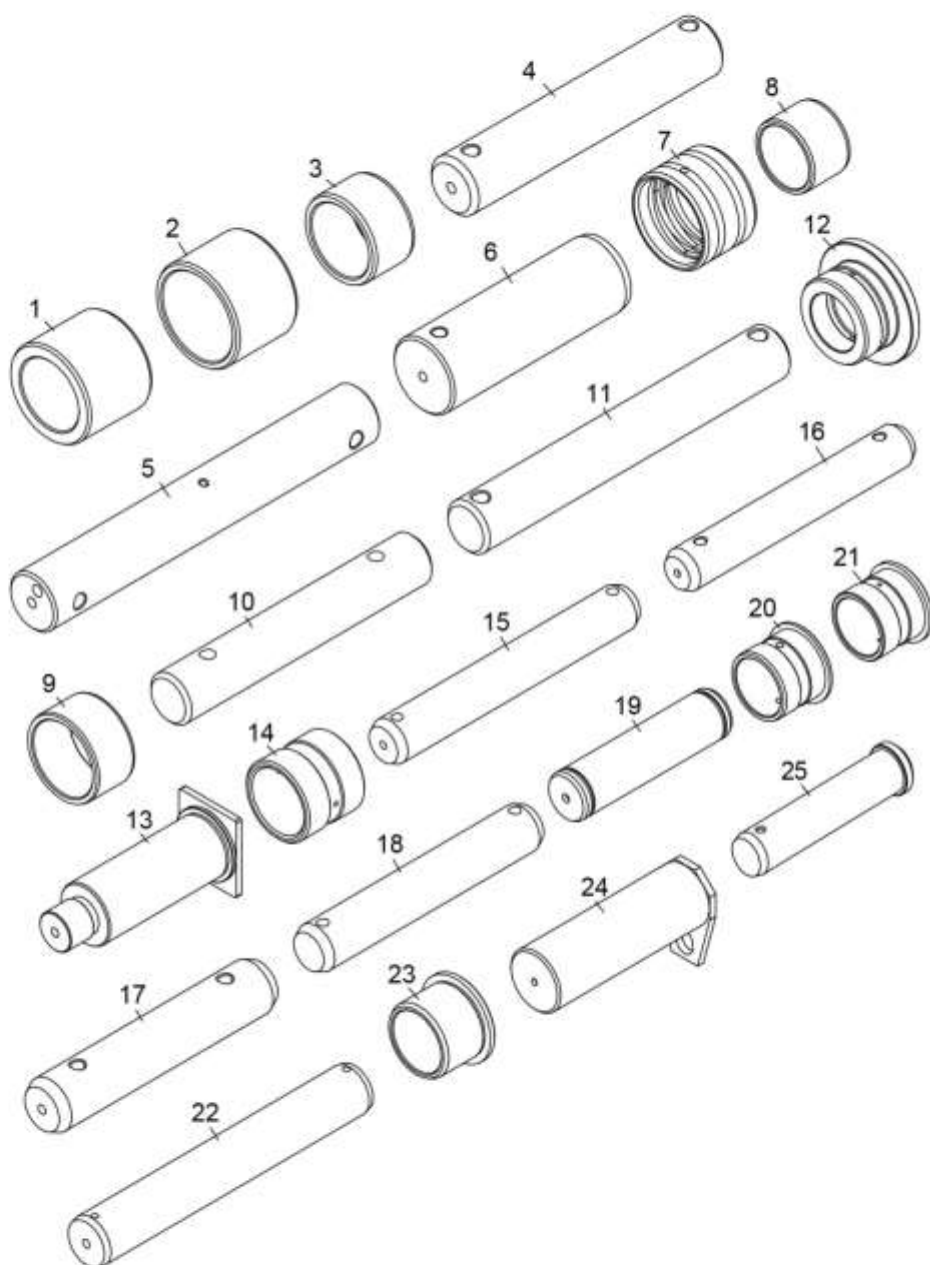

KIT - 96 DIANTEIRO

(KT MF96 D)

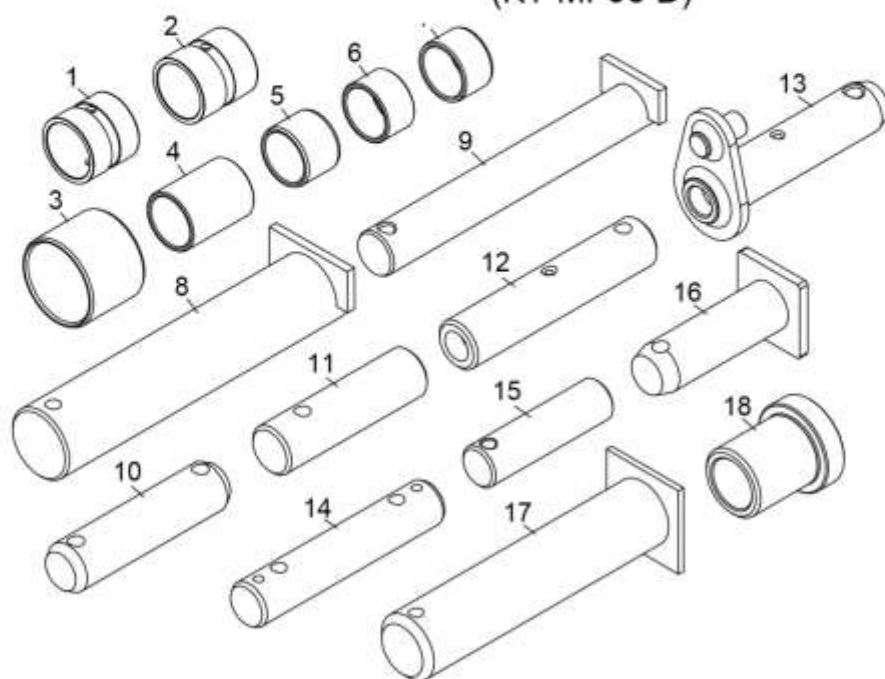

POS.	CÓDIGO
1	2710881
2	2710891
3	862691
4	863147
5	3147313
6	862627
7	2710883
8	862617
9	862620
10	862663
11	862672
12	862661
13	862967
14	863064
15	036452
16	862665
17	036799
18	862589

KIT - 96 DIANTEIRO 4X4

(KT MF96 D 4X4)

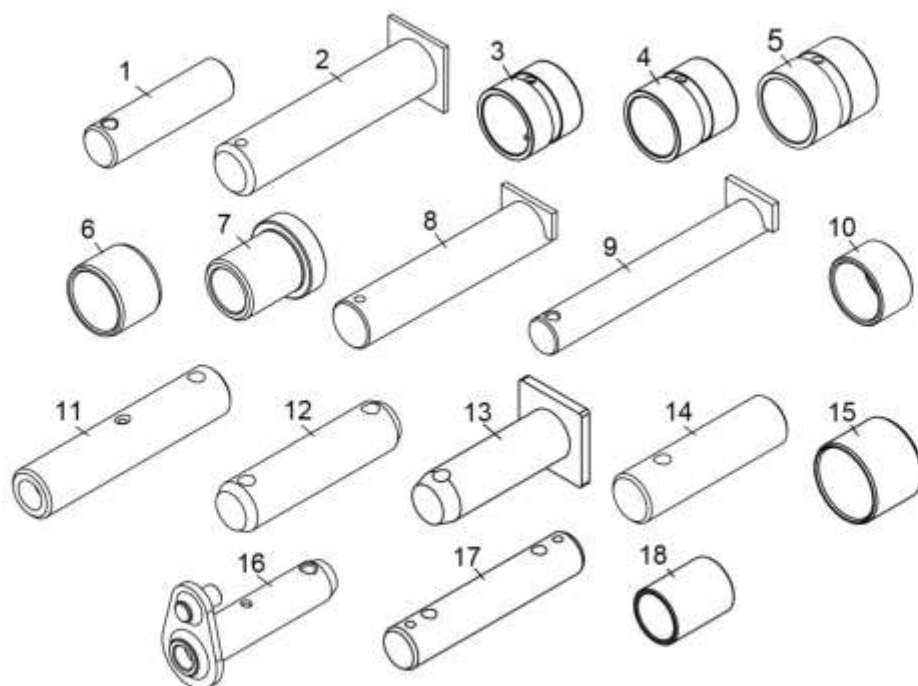

POS.	CÓDIGO
1	036452
2	036799
3	2710881
4	2710883
5	2710891
6	3147313M1
7	862589
8	862617
9	862620
10	862627
11	862661
12	862663
13	862665
14	862672
15	862691
16	862967
17	863064
18	863147

KIT - 750 DIANTEIRO FASE 1

(KT MF750 D FASE1)

POS.	CÓDIGO
1	2710881
2	2710891
3	862691
4	863147
5	3147313
6	862627
7	862617
8	862620
9	862663
10	862672
11	862661
12	862665
13	862967
14	862589

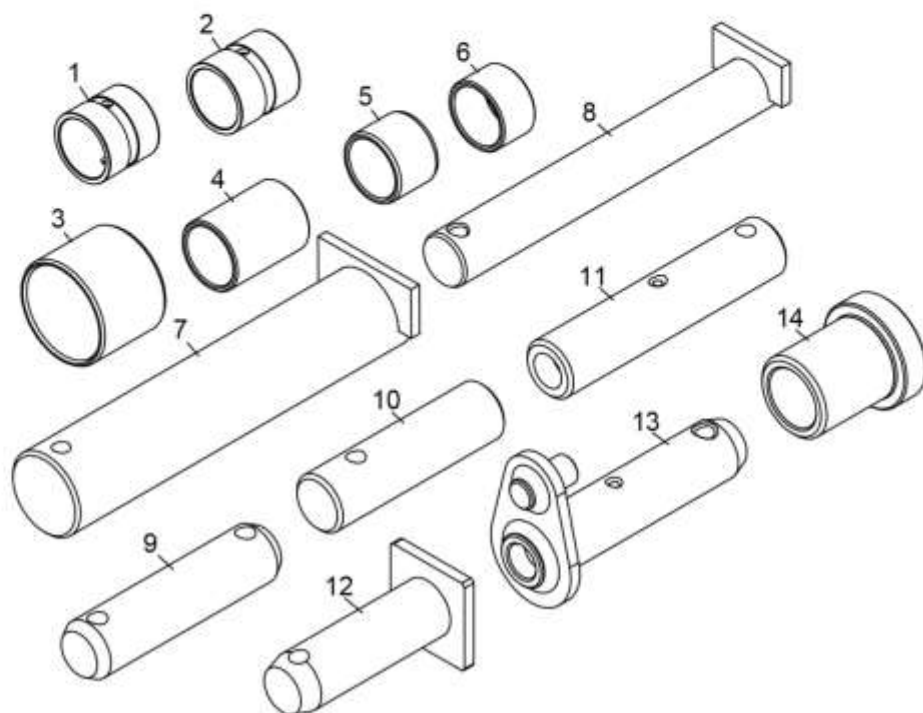

KIT - 750 DIANTEIRO FASE 2

(KT MF750 D FASE2)

POS.	CÓDIGO
1	2710881
2	2710891
3	2710883
4	036452
5	862691
6	863147
7	3147313
8	862627
9	862589
10	862617
11	862620
12	863064
13	862663
14	862661
15	862665
16	862672
17	036799
18	862967

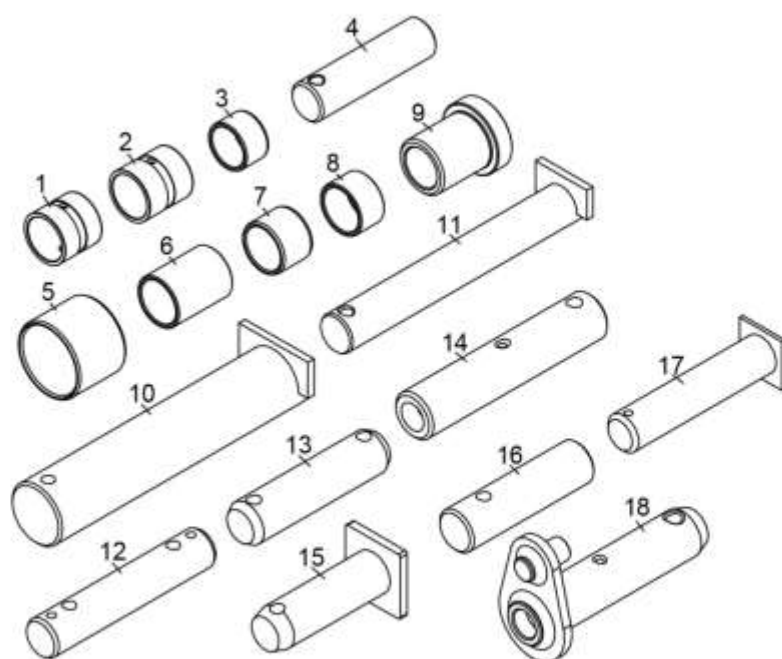

KIT - 750 TRASEIRO FASE 1 (KT MF750 T FASE1)

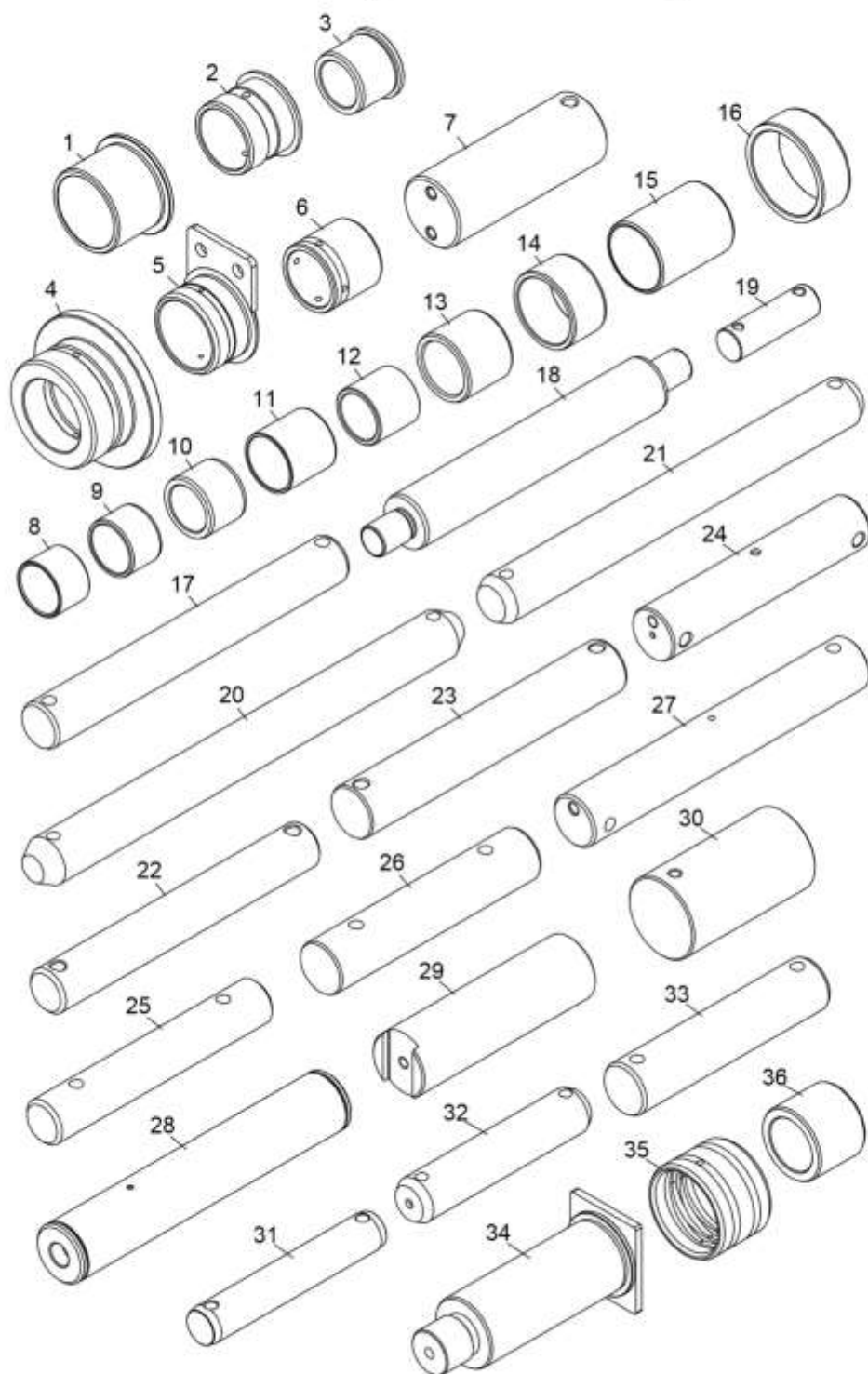

POS.	CODIGO
1	3411872
2	3500047
3	871705
4	3411868
5	3587902
6	871352
7	2750504
8	3147278
9	3175777
10	871353
11	3149143
12	871710
13	874620
14	3175831
15	3588880
16	3409139
17	871455
18	871453
19	824996
20	871729
21	871454
22	3411480
23	1484073
24	871458
25	3411479
26	871460
27	3411146
28	3587841
29	3587846
30	3409001
31	871792
32	3408490
33	871456
34	3411873
35	2757721
36	028925

KIT - 750 TRASEIRO FASE 2 (KT MF750 T FASE2)

POS.	CÓDIGO
1	037919
2	3175831
3	028925
4	042651
5	3175777
6	3511550
7	3411873
8	3411868
9	3411872
10	3501770
11	3501015
12	3500047
13	2757721
14	3500009
15	3500037
16	042765
17	043716
18	3500036
19	3411479
20	3500046
21	3501769
22	3500035
23	3500034
24	3411480
25	043698

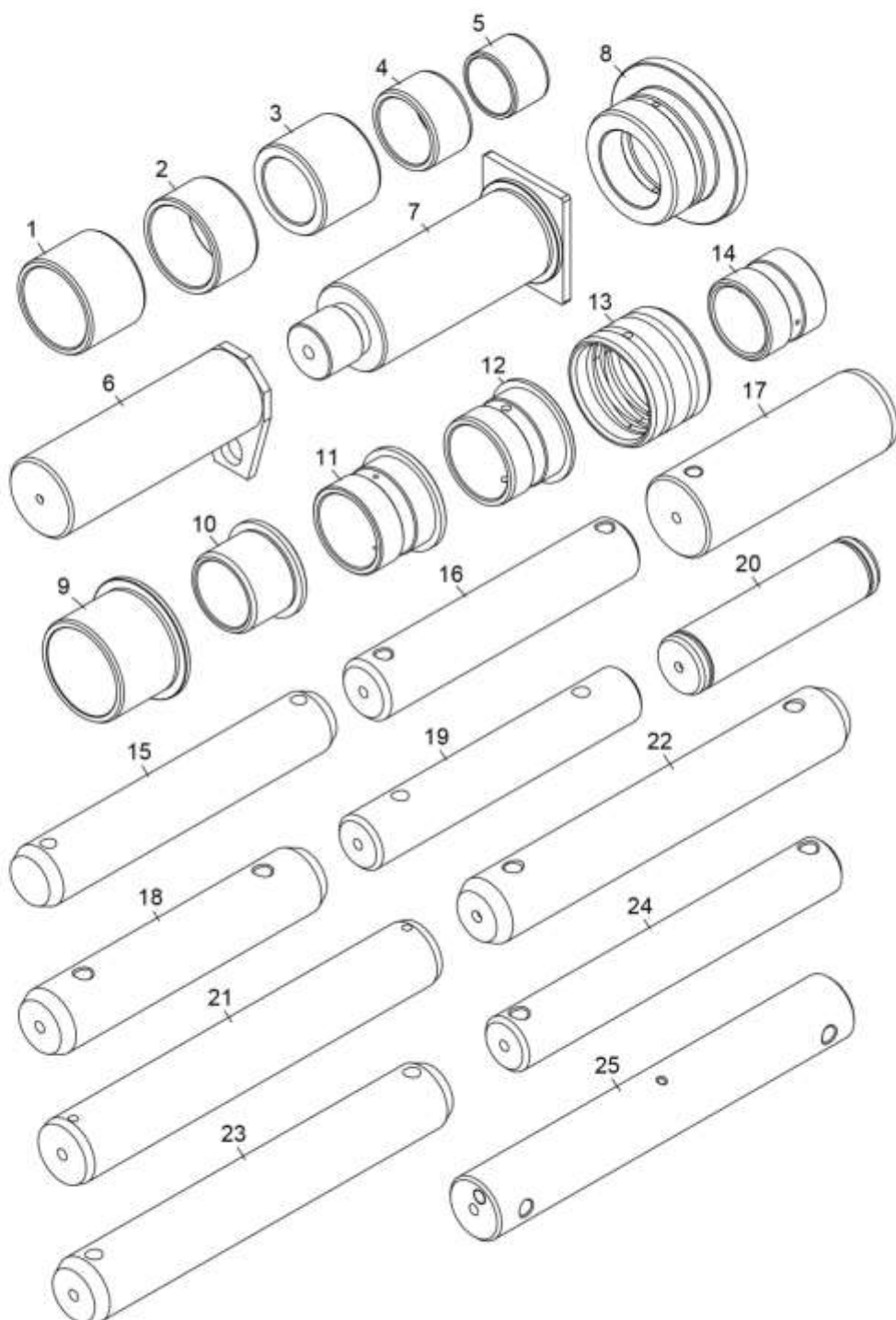

KIT DA ARTICULAÇÃO CENTRAL 2533549

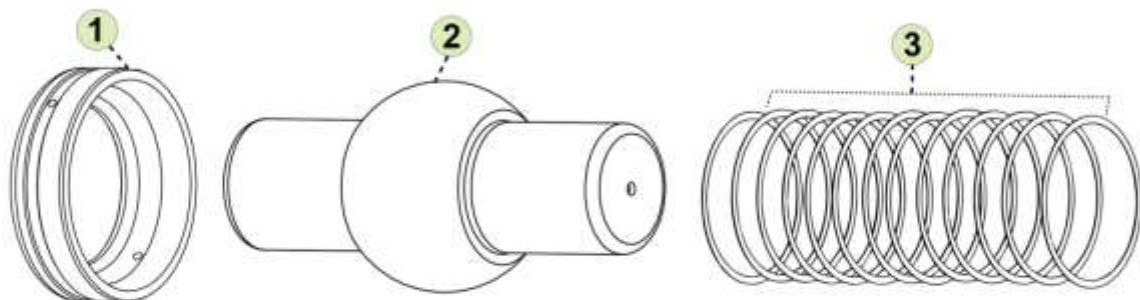

Não vendemos peças separadamente













CAPA
2533549 CAPA













PINO BOLA
2533549 PINO

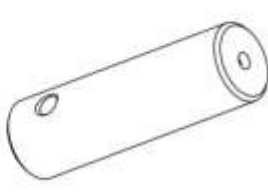
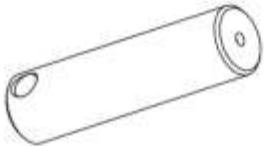
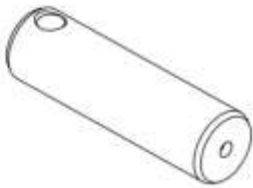

CALÇO
2533549 CALÇO

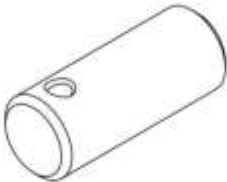
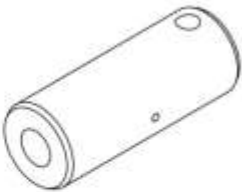
ACOMPANHA

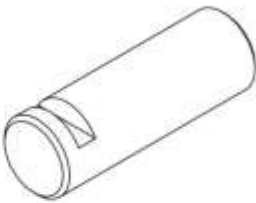
POS.	QTD.	DESCRIÇÃO
1	02	Capa
2	01	Pino Bola
3	13	Calço

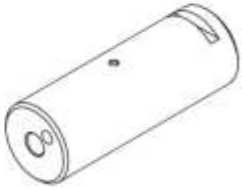
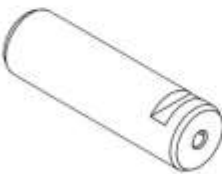
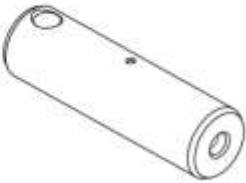
<p>BUCHA</p>  <p>538585</p>	<p>BUCHA</p>  <p>542031</p>	<p>BUCHA</p>  <p>564129</p>	<p>BUCHA</p>  <p>568482</p>
<p>BUCHA</p>  <p>585007</p>	<p>BUCHA</p>  <p>587908</p>	<p>BUCHA</p>  <p>589023</p>	<p>BUCHA</p>  <p>1508238</p>
<p>BUCHA</p>  <p>1502644</p>	<p>BUCHA</p>  <p>1508731</p>	<p>BUCHA</p>  <p>1521218</p>	<p>BUCHA</p>  <p>1521241</p>

<p>BUCHA</p>  <p>1522035</p>	<p>BUCHA</p>  <p>1540234</p>	<p>BUCHA</p>  <p>2540853</p>	<p>BUCHA</p>  <p>2540854</p>
<p>BUCHA</p>  <p>3302759</p>	<p>BUCHA</p>  <p>3300403</p>	<p>PINO</p>  <p>513372</p>	<p>PINO</p>  <p>514921</p>
<p>PINO</p>  <p>536100</p>	<p>PINO</p>  <p>542631</p>	<p>PINO</p>  <p>571022</p>	<p>PINO</p>  <p>587900</p>
<p>PINO</p>  <p>587901</p>	<p>PINO</p>  <p>590061</p>	<p>PINO</p>  <p>12705621</p>	<p>PINO</p>  <p>1508556</p>
<p>PINO</p>  <p>1508569</p>	<p>PINO</p>  <p>1508570</p>	<p>PINO</p>  <p>1509147</p>	<p>PINO</p>  <p>1511516</p>

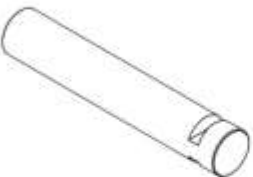
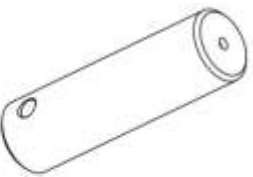
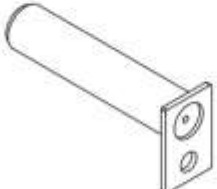
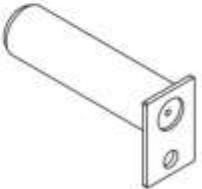
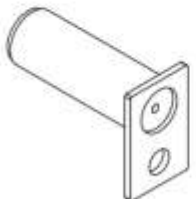
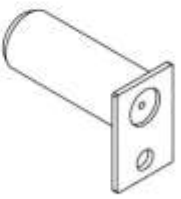
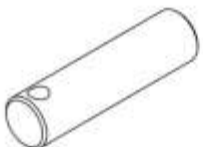
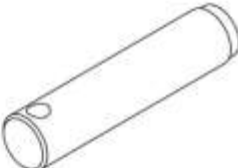
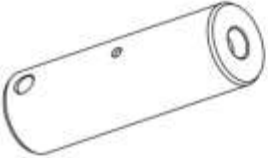
<p>PINO</p>  <p>1529902</p>	<p>PINO</p>  <p>1530602</p>	<p>PINO</p>  <p>1543086</p>	<p>PINO</p>  <p>1543088</p>
<p>PINO</p>  <p>2555864</p>	<p>PINO</p>  <p>2555865</p>	<p>PINO</p>  <p>2555866</p>	<p>PINO</p>  <p>2555867</p>
<p>PINO</p>  <p>536100A</p>	<p>PINO</p>  <p>536100M</p>	<p>PINO</p>  <p>568483M</p>	

KIT - 55C (KT 55C)

POS.	CÓDIGO
1	2540854
2	538585
3	KT 2533549
4	513372
5	1509147
6	1508556
7	2555864
8	2555865
9	12705621
10	2555867
11	2540853
12	2555866

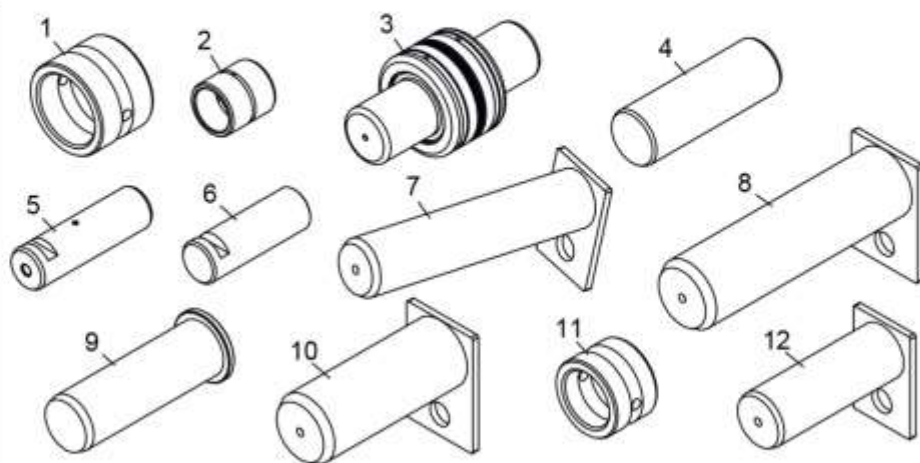

KIT - 75 (KT 75)

POS.	CÓDIGO
1	1529902
2	568483A ANTIGO
3	587901
4	590061
5	514921
6	587900
7	536100
8	542631
9	571022
10	1530602
11	3300403
12	568482
13	587908
14	538585
15	585007
16	1502644
17	564129

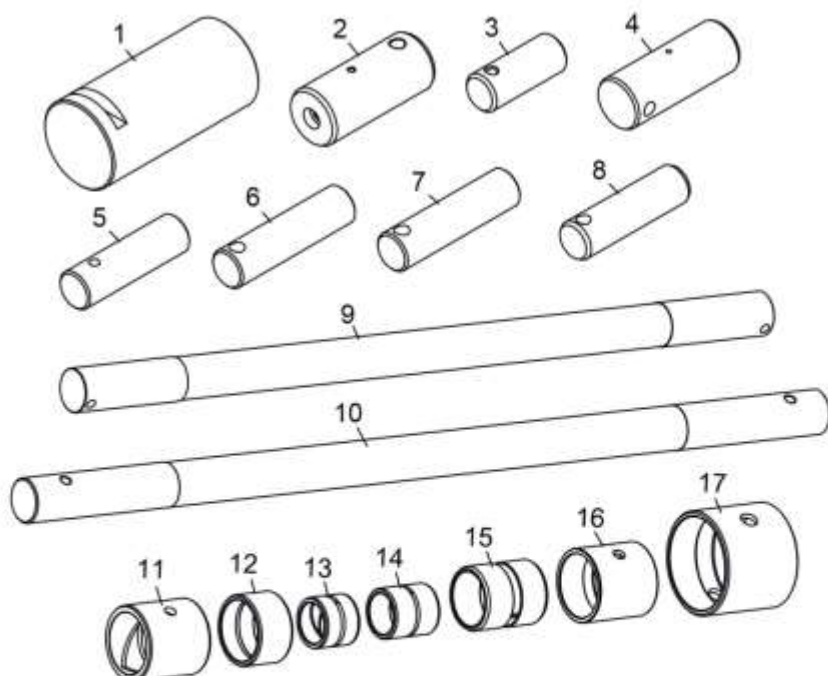

PORCA



70072037

CARÇAÇA DE ARTICULAÇÃO



70071980 LD

CARÇAÇA DE ARTICULAÇÃO

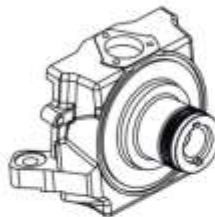

















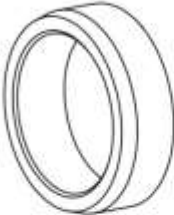
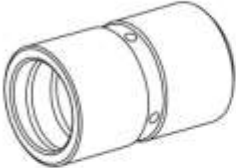

70071981 LE

PORTADOR PLANETÁRIO



70072048

<p>BUCHA</p>  <p>32820000</p>	<p>BUCHA</p>  <p>32820017</p>	<p>BUCHA</p>  <p>32820023</p>	<p>BUCHA</p>  <p>32820029</p>					
<p>BUCHA</p>  <p>32820031</p>	<p>BUCHA</p>  <p>32820072</p>	<p>BUCHA</p>  <p>32820074</p>	<p>BUCHA</p>  <p>32820075</p>					
<p>BUCHA</p>  <p>32820077</p>	<p>BUCHA</p>  <p>32820089</p>	<p>BUCHA</p>  <p>32820091</p>	<p>BUCHA</p>  <p>32820160</p>					
<p>BUCHAS</p> 	<table border="1"> <tbody> <tr><td>32820210</td></tr> <tr><td>32820211</td></tr> <tr><td>32820212</td></tr> <tr><td>32820222</td></tr> <tr><td>32820223</td></tr> </tbody> </table>	32820210	32820211	32820212	32820222	32820223	<p>BUCHA</p>  <p>32820286</p>	<p>BUCHA</p>  <p>32820287</p>
32820210								
32820211								
32820212								
32820222								
32820223								
<p>BUCHA</p>  <p>32820288</p>	<p>BUCHA</p>  <p>32820290</p>	<p>BUCHA</p>  <p>32820459</p>	<p>BUCHA</p>  <p>32840012</p>					

*Imagem ilustrativa, os códigos não são convênios

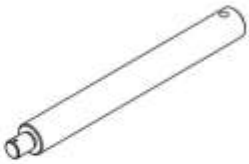
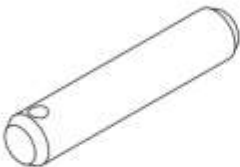
<p>PINO</p>  <p>51537</p>	<p>PINO</p>  <p>32140004</p>	<p>PINOS</p>  <table border="1" style="margin-left: auto; margin-right: auto;"> <tr><td>32140001</td></tr> <tr><td>32140002</td></tr> <tr><td>32140003</td></tr> <tr><td>32140005</td></tr> </table>	32140001	32140002	32140003	32140005
32140001						
32140002						
32140003						
32140005						

*Imagem ilustrativa, os códigos não são conversões.

<p>PINO</p>  <p>32340179</p>	<p>PINO</p>  <p>32340420</p>	<p>PINO</p>  <p>32341021</p>
--	--	--

PINOS PARA MÁQUINA MOTOCANA

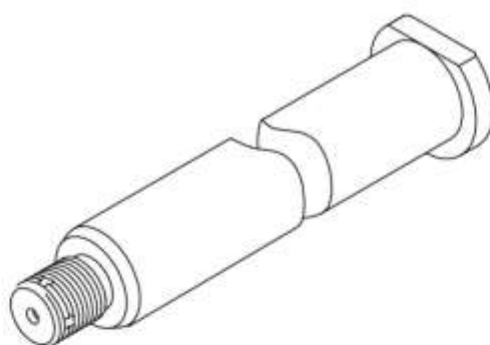

32340001	32340701	32340958
32340004	32340708	32341018
32340007	32340709	32341019
32340031	32340712	32341020
32340041	32340838	32341024
32340080	32340846	32341026
32340537	32340859	32341048
32340538	32340955	32341050
32340595	32340956	32341055
32340608	32340957	32345000

*Imagem ilustrativa, os códigos não são conversões.

CARÇAÇA DE ARTICULAÇÃO



2170401 LD

CARÇAÇA DE ARTICULAÇÃO







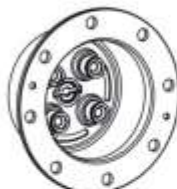



































2170402 LE













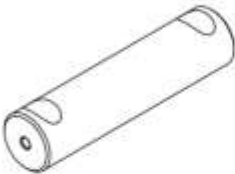
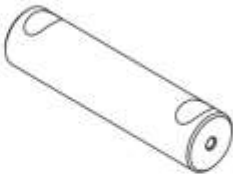
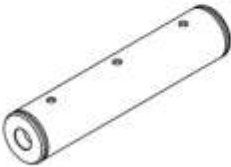



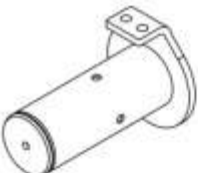

PORTADOR PLANETÁRIO



2170504

<p>BUCHA</p>  <p>219001100</p>	<p>BUCHA</p>  <p>219001101</p>	<p>BUCHA</p>  <p>219001103</p>	<p>BUCHA</p>  <p>219001104</p>
<p>BUCHA</p>  <p>219001105</p>	<p>BUCHA</p>  <p>219001106</p>	<p>BUCHA</p>  <p>219001109</p>	<p>BUCHA</p>  <p>219001110</p>
<p>BUCHA</p>  <p>219001111</p>	<p>BUCHA</p>  <p>219001124</p>	<p>BUCHA</p>  <p>219001880</p>	<p>BUCHA</p>  <p>370060001</p>
<p>BUCHA</p>  <p>370060002</p>	<p>BUCHA</p>  <p>370060011</p>	<p>BUCHA</p>  <p>370060012</p>	<p>BUCHA</p>  <p>370060014</p>
<p>BUCHA</p>  <p>370060016</p>	<p>BUCHA</p>  <p>370060017</p>	<p>BUCHA</p>  <p>370060038</p>	<p>BUCHA</p>  <p>370060039</p>

<p>BUCHA</p>  <p>370060040</p>	<p>BUCHA</p>  <p>370060041</p>	<p>BUCHA</p>  <p>370060046</p>	<p>BUCHA</p>  <p>370060091</p>
<p>BUCHA</p>  <p>370060117</p>	<p>BUCHA</p>  <p>370060118</p>	<p>BUCHA</p>  <p>370060119</p>	<p>BUCHA</p>  <p>370060120</p>
<p>BUCHA</p>  <p>370060121</p>	<p>BUCHA</p>  <p>370060123</p>	<p>BUCHA</p>  <p>370060493</p>	<p>BUCHA</p>  <p>370060543</p>
<p>BUCHA</p>  <p>370060544</p>	<p>BUCHA</p>  <p>370060545</p>	<p>BUCHA</p>  <p>370060546</p>	<p>BUCHA</p>  <p>370060547</p>
<p>BUCHA</p>  <p>370060548</p>	<p>BUCHA</p>  <p>370060570</p>	<p>BUCHA</p>  <p>370060571</p>	<p>BUCHA</p>  <p>370060756</p>

<p>BUCHA</p>  <p>370060757</p>	<p>BUCHA</p>  <p>370060771</p>	<p>PINO</p>  <p>213000632</p>	<p>PINO</p>  <p>301009787</p>
<p>PINO</p>  <p>370060003</p>	<p>PINO</p>  <p>370060004</p>	<p>PINO</p>  <p>370060005</p>	<p>PINO</p>  <p>370060006</p>
<p>PINO</p>  <p>370060008</p>	<p>PINO</p>  <p>370060009</p>	<p>PINO</p>  <p>370060010</p>	<p>PINO</p>  <p>370060032</p>
<p>PINO</p>  <p>370060037</p>	<p>PINO</p>  <p>370060045</p>	<p>PINO</p>  <p>370060047</p>	<p>PINO</p>  <p>370060049</p>
<p>PINO</p>  <p>370060050</p>	<p>PINO</p>  <p>370060051</p>	<p>PINO</p>  <p>370060052</p>	<p>PINO</p>  <p>370060053</p>

<p>PINO</p>  <p>370060054</p>	<p>PINO</p>  <p>370060055</p>	<p>PINO</p>  <p>370060056</p>	<p>PINO</p>  <p>370060057</p>
<p>PINO</p>  <p>370060127</p>	<p>PINO</p>  <p>370060128</p>	<p>PINO</p>  <p>370060129</p>	<p>PINO</p>  <p>370060180</p>
<p>PINO</p>  <p>370060395</p>	<p>PINO</p>  <p>370060473</p>	<p>PINO</p>  <p>370060495</p>	<p>PINO</p>  <p>370060770</p>
<p>PINO</p>  <p>100000037232</p>	<p>PINO</p>  <p>213000632M</p>	<p>RÓTULA</p>  <p>219000020</p>	<p>ENGRENAGEM</p>  <p>219000692</p>
<p>ENGRENAGEM</p>  <p>219001024</p>			

POS.	CÓDIGO
1	219001104
2	219001105
3	219001100
4	219001106
5	370060054
6	370060057
7	370060037
8	370060571
9	219001103
10	219001124
11	370060570
12	370060547
13	370060123
14	370060546
15	370060545
16	370060543
17	370060544
18	370060039
19	370060548
20	370060014
21	370060118
22	370060040
23	370060122
24	370060117
25	370060756
26	370060002
27	370060757
28	219000020
29	370060038
30	370060012
31	370060493
32	370060011
33	370060001
34	370060041
35	370060473
36	370060091
37	370060053
38	370060052
39	370060495
40	370060050
41	370060049
42	370060047
43	370060051
44	370060045
45	370060127
46	370060032
47	370060010
48	370060056
49	370060180
50	370060009
51	219001101



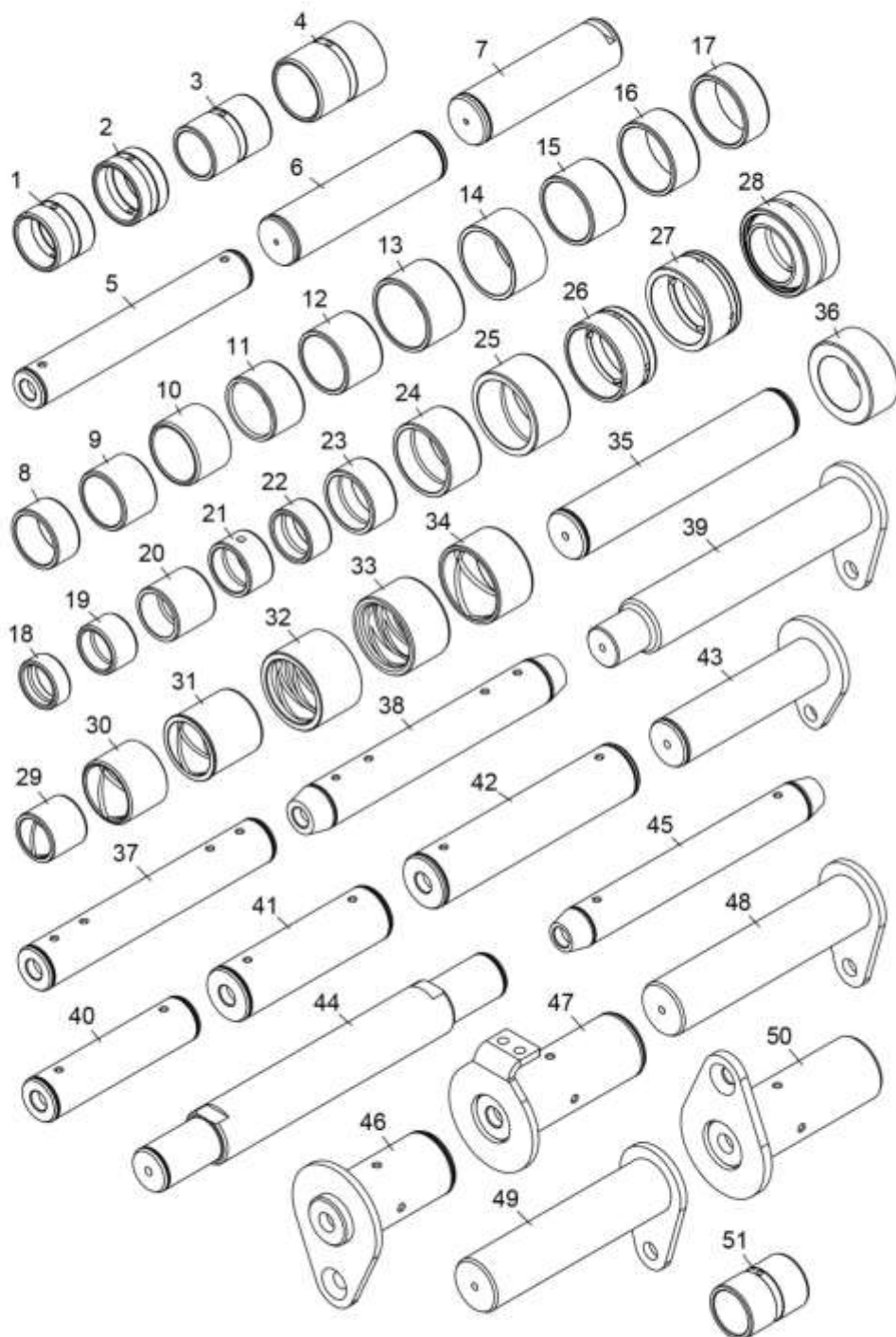



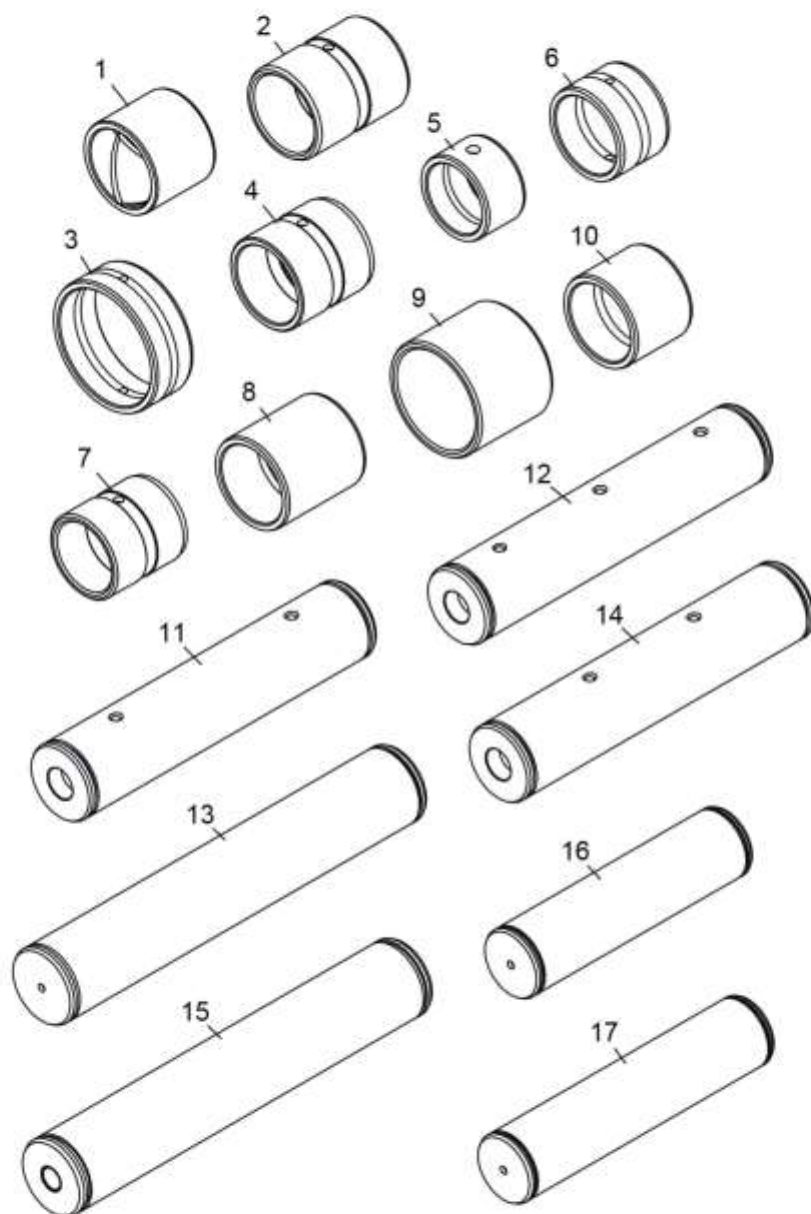











KIT - RK406B TRASEIRO (KT 406B T)









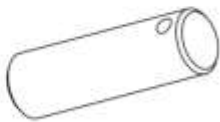

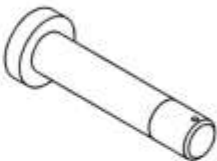

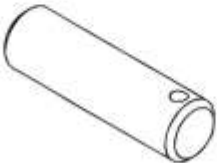
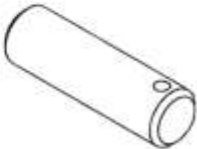
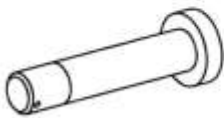

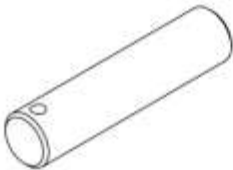











KIT - RK406B DIANTEIRO (KT 406B D)





















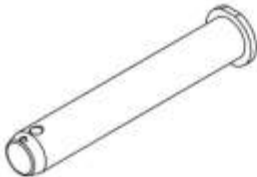
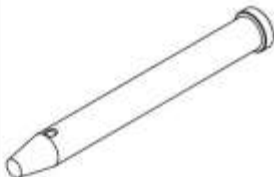
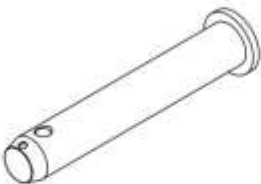
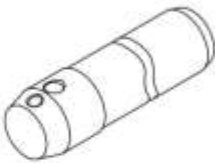

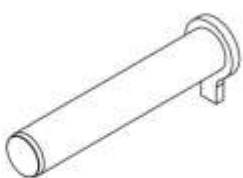
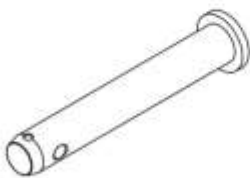
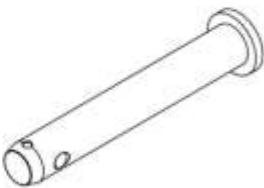
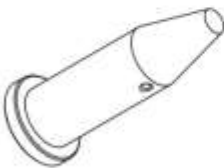
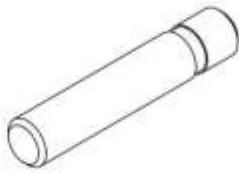

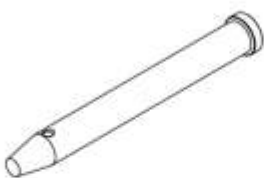
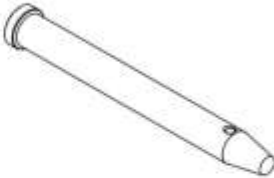

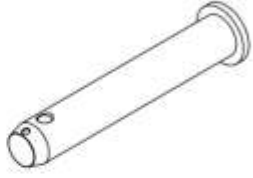
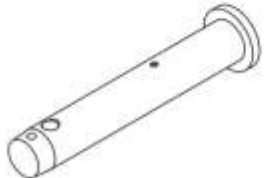
POS.	CÓDIGO
1	370060046
2	219001109
3	370060016
4	219001110
5	370060118
6	370060017
7	219001111
8	370060121
9	219001880
10	370060120
11	370060128
12	370060003
13	370060004
14	370060129
15	370060006
16	370060005
17	370060055



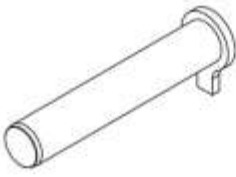
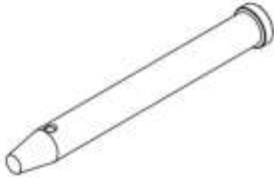

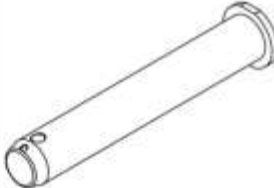
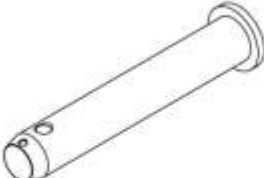

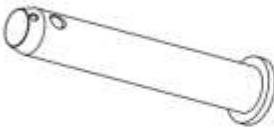
<p>BUCHA</p>  <p>1911053</p>	<p>BUCHA</p>  <p>2072018</p>	<p>BUCHA</p>  <p>2071022</p>	<p>BUCHA</p>  <p>2074066</p>
<p>BUCHA</p>  <p>2609020</p>	<p>BUCHA</p>  <p>19110869</p>	<p>BUCHA</p>  <p>19110990</p>	<p>BUCHA</p>  <p>19111164</p>
<p>BUCHA</p>  <p>19111180</p>	<p>BUCHA</p>  <p>20720174</p>	<p>BUCHA</p>  <p>20720182</p>	<p>BUCHA</p>  <p>20720204</p>
<p>BUCHA</p>  <p>26010039</p>	<p>BUCHA</p>  <p>26030048</p>	<p>BUCHA</p>  <p>26030145</p>	<p>BUCHA</p>  <p>26090202</p>
<p>BUCHA</p>  <p>26090229</p>	<p>PINO</p>  <p>2043009</p>	<p>PINO</p>  <p>2043012</p>	<p>PINO</p>  <p>2043015</p>

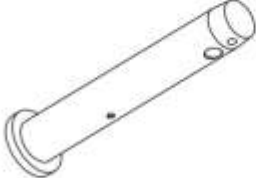
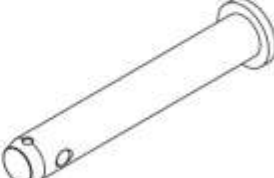
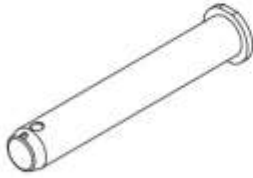
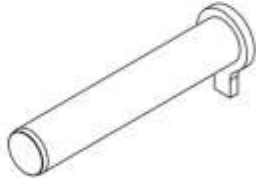









<p>PINO</p>  <p>2045029</p>	<p>PINO</p>  <p>2046029</p>	<p>PINO</p>  <p>2046053</p>	<p>PINO</p>  <p>20430141</p>
<p>PINO</p>  <p>20430192</p>	<p>PINO</p>  <p>20430206</p>	<p>PINO</p>  <p>20460229</p>	<p>PINO</p>  <p>20490519</p>
<p>PINO</p>  <p>47002150</p>			

<p>BUCHA</p>  <p>10759319</p>	<p>BUCHA</p>  <p>10989145</p>	<p>BUCHA</p>  <p>11000242</p>	<p>BUCHA</p>  <p>11016610</p>
<p>BUCHA</p>  <p>11097916</p>	<p>BUCHA</p>  <p>11216201</p>	<p>BUCHA</p>  <p>11140144</p>	<p>BUCHA</p>  <p>11751558</p>
<p>BUCHA</p>  <p>60084731</p>	<p>BUCHA</p>  <p>67006332</p>	<p>BUCHA</p>  <p>67006611</p>	<p>BUCHA</p>  <p>A820202002971</p>
<p>BUCHA</p>  <p>A820202002972</p>	<p>BUCHA</p>  <p>A82020200974</p>	<p>BUCHA</p>  <p>A820202002008</p>	<p>BUCHA</p>  <p>A820202002975</p>
<p>BUCHA</p>  <p>A820202002976</p>	<p>BUCHA</p>  <p>A820202003320</p>	<p>BUCHA</p>  <p>A820202003322</p>	<p>BUCHA</p>  <p>A820202003323</p>

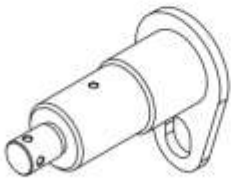
<p>BUCHA</p>  <p>A820202005320</p>	<p>BUCHA</p>  <p>A820202005379</p>	<p>BUCHA</p>  <p>A820202005380</p>	<p>BUCHA</p>  <p>A820202005381</p>
<p>BUCHA</p>  <p>A820208000357</p>	<p>BUCHA</p>  <p>A820208000358</p>	<p>BUCHA</p>  <p>A820208000360</p>	<p>PINO</p>  <p>10095077</p>
<p>PINO</p>  <p>10137541</p>	<p>PINO</p>  <p>10137999</p>	<p>PINO</p>  <p>10988337</p>	<p>PINO</p>  <p>11052074</p>
<p>PINO</p>  <p>11696987</p>	<p>PINO</p>  <p>11795851</p>	<p>PINO</p>  <p>11856384</p>	<p>PINO</p>  <p>11994050</p>
<p>PINO</p>  <p>12597346</p>	<p>PINO</p>  <p>12597347</p>	<p>PINO</p>  <p>12783158</p>	<p>PINO</p>  <p>12915776</p>

<p>PINO</p>  <p>13351842</p>	<p>PINO</p>  <p>13351843</p>	<p>PINO</p>  <p>13351867</p>	<p>PINO</p>  <p>67006326</p>
<p>PINO</p>  <p>67006327</p>	<p>PINO</p>  <p>67006328</p>	<p>PINO</p>  <p>67006329</p>	<p>PINO</p>  <p>67006330</p>
<p>PINO</p>  <p>67006610</p>	<p>PINO</p>  <p>67006637</p>	<p>PINO</p>  <p>67006671</p>	<p>PINO</p>  <p>67007776</p>
<p>PINO</p>  <p>A810303990031</p>	<p>PINO</p>  <p>A810303990032</p>	<p>PINO</p>  <p>A810312110110</p>	<p>PINO</p>  <p>A810312110111</p>
<p>PINO</p>  <p>A810312110112</p>	<p>PINO</p>  <p>A810312110113</p>	<p>PINO</p>  <p>A810312110014</p>	<p>PINO</p>  <p>A810312110019</p>

<p>EIXO</p>  <p>A820301021346</p>	<p>EIXO</p>  <p>A820301021348</p>	<p>EIXO</p>  <p>A820301021349</p>	<p>FLANGE</p>  <p>67006331</p>
<p>FLANGE</p>  <p>11795852</p>	<p>GRUPO PARA ESTEIRA</p>  <p>GR SANY 135</p>		

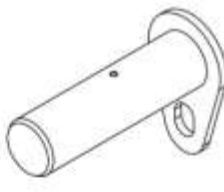
<p>BUCHA</p>  <p>4043000121</p>	<p>BUCHA</p>  <p>4043000123</p>	<p>BUCHA</p>  <p>4043000124</p>	<p>BUCHA</p>  <p>4043000218</p>
<p>PINO</p>  <p>2110900260</p>	<p>PINO</p>  <p>3110900011</p>	<p>PINO</p>  <p>4043000112</p>	<p>PINO</p>  <p>4043000119</p>
<p>PINO</p>  <p>4043000120</p>	<p>PINO</p>  <p>4043000202</p>	<p>PINO</p>  <p>4043000204</p>	<p>PINO</p>  <p>4043000205</p>

CARÇAÇA DE ARTICULAÇÃO

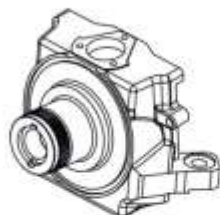

101057538 LD

CARÇAÇA DE ARTICULAÇÃO



101057539 LE

PORTADOR PLANETÁRIO



101057591

PORTADOR PLANETÁRIO

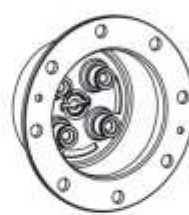

101057616

BUCHA



47093340

PIVÔ
(FORJADO)

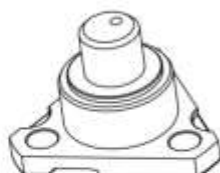

47103122

PORCA



47103548

PORTADOR PLANETÁRIO



47113065

<p>BUCHA</p>  <p>10047050</p>	<p>PIVÔ (FORJADO)</p>  <p>10047156</p>	<p>PORCA</p>  <p>10047200</p>	<p>PORTADOR PLANETÁRIO</p>  <p>10047211</p>
---	--	---	---

CONJUNTO CARÇAÇA DE ARTICULAÇÃO PARA MÁQUINAS VALMET / VALTRA

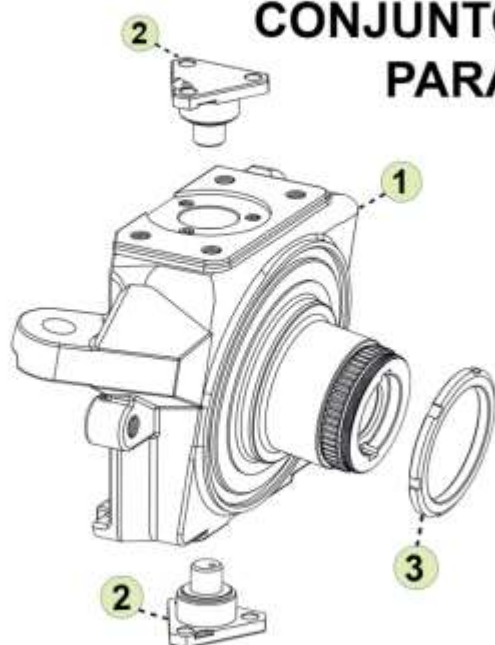

CARÇAÇA DE ARTICULAÇÃO

80599920 LE
80599820 LD
81700300 LE
81700200 LD

PIVÔ













80607500
80296100













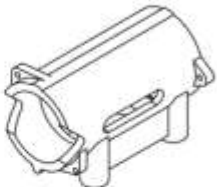



PORCA RANHURADA







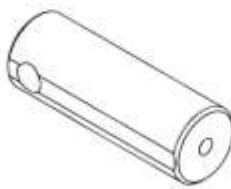

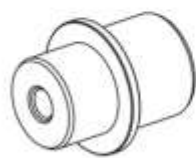
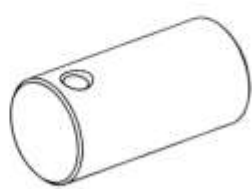

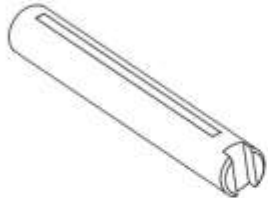
80604000

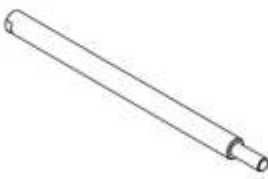









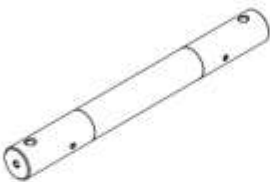



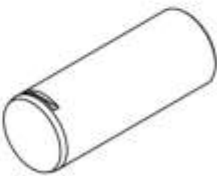

ACOMPANHA



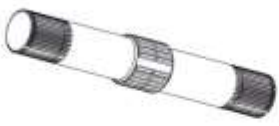









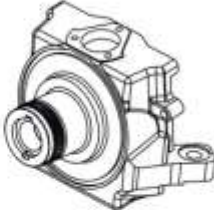





POS.	QTD.	DESCRIÇÃO
1	01	Carçaça de Articulação
2	02	Pino Pivô
3	01	Porca Ranhurada





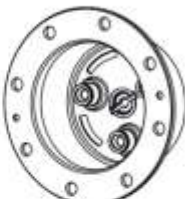











<p>BUCHA</p>  <p>164490</p>	<p>BUCHA</p>  <p>216400</p>	<p>BUCHA</p>  <p>222630</p>	<p>BUCHA</p>  <p>222641</p>
<p>BUCHA</p>  <p>222720</p>	<p>BUCHA</p>  <p>224241</p>	<p>BUCHA</p>  <p>224230</p>	<p>BUCHA</p>  <p>641590</p>
<p>BUCHA</p>  <p>651950</p>	<p>BUCHA</p>  <p>30174000</p>	<p>BUCHA</p>  <p>34056800</p>	<p>BUCHA</p>  <p>34056900</p>

<p>BUCHA</p>  <p>34057100</p>	<p>BUCHA</p>  <p>34057700</p>	<p>BUCHA</p>  <p>3588020</p>	<p>BUCHA</p>  <p>80086700</p>
<p>BUCHA</p>  <p>80258200</p>	<p>BUCHA</p>  <p>80608400</p>	<p>BUCHA</p>  <p>81325900</p>	<p>BUCHA</p>  <p>81339910</p>
<p>BUCHA</p>  <p>81339920</p>	<p>BUCHA</p>  <p>81710900</p>	<p>BUCHA</p>  <p>81711000</p>	<p>BUCHA</p>  <p>81711300</p>
<p>BUCHA</p>  <p>81861010 (Nylon)</p>	<p>BUCHA</p>  <p>81884400</p>	<p>BUCHA</p>  <p>82444500</p>	<p>BUCHA</p>  <p>83996500</p>
<p>PINO</p>  <p>440520</p>	<p>PINO</p>  <p>440530</p>	<p>PINO</p>  <p>440600</p>	<p>PINO</p>  <p>440680</p>



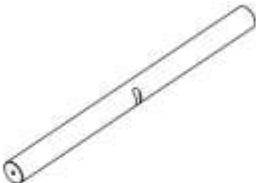















<p>PINO</p>  <p>440790</p>	<p>PINO</p>  <p>581430</p>	<p>PINO</p>  <p>820731</p>	<p>PINO</p>  <p>31337310</p>
<p>PINO</p>  <p>80689710</p>	<p>PINO</p>  <p>80717700 3/4"</p>	<p>PINO</p>  <p>80717800 5/8"</p>	<p>PIVÔ (FORJADO)</p>  <p>34051800</p>
<p>PIVÔ (FORJADO)</p>  <p>34057300A</p>	<p>PIVÔ (FORJADO)</p>  <p>34057300M</p>	<p>PIVÔ (FORJADO)</p>  <p>80607500</p>	<p>PIVÔ (FORJADO)</p>  <p>81263600</p>
<p>PIVÔ (FORJADO)</p>  <p>81263700</p>	<p>PIVÔ (FORJADO)</p>  <p>80296100</p>	<p>RÓTULA</p>  <p>LA9181</p>	<p>EIXO</p>  <p>158791</p>
<p>EIXO</p>  <p>228360</p>	<p>EIXO</p>  <p>228361</p>	<p>EIXO</p>  <p>242410</p>	<p>EIXO</p>  <p>260061</p>







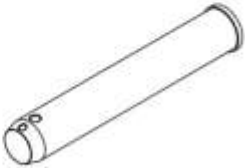

<p>EIXO</p>  <p>261100</p>	<p>EIXO</p>  <p>592240</p>	<p>EIXO</p>  <p>614030</p>	<p>EIXO</p>  <p>822250</p>								
<p>EIXO</p>  <p>823870</p>	<p>EIXO</p>  <p>30171700</p>	<p>EIXO</p>  <p>30302210</p>	<p>EIXO</p>  <p>31361440</p>								
<p>EIXO</p>  <p>45031120</p>	<p>EIXO</p>  <p>81397410</p>	<p>EIXO</p>  <p>81674700</p>	<p>EIXO</p>  <p>82127000</p>								
<p>EIXO</p>  <p>83438700</p>	<p>EIXO</p>  <p>85692300</p>	<p>EIXO</p>  <p>86320100</p>	<p>EIXO</p>  <p>86309200</p>								
<p>PONTA DE EIXO</p>  <p>80205400</p>	<p>MANGAS DE EIXO</p>  <table border="1"> <tbody> <tr> <td>206091</td> <td>656091</td> </tr> <tr> <td>206092</td> <td>80331200</td> </tr> <tr> <td>216610</td> <td>80456810</td> </tr> <tr> <td>217700</td> <td>80881000</td> </tr> </tbody> </table>		206091	656091	206092	80331200	216610	80456810	217700	80881000	<p>MANGA DE EIXO</p>  <p>216690</p>
206091	656091										
206092	80331200										
216610	80456810										
217700	80881000										

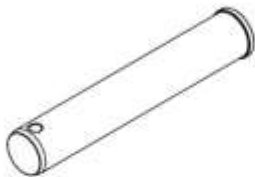
<p>MANGA DE EIXO</p>  <p>626090</p>	<p>MANGA DE EIXO</p>  <p>820950 LE</p>	<p>MANGA DE EIXO</p>  <p>821010 LD</p>	<p>CARCAÇA DE ARTICULAÇÃO</p>  <p>80599820 LD</p>
<p>CARCAÇA DE ARTICULAÇÃO</p>  <p>80599920 LE</p>	<p>CARCAÇA DE ARTICULAÇÃO</p>  <p>81700200 LD</p>	<p>CARCAÇA DE ARTICULAÇÃO</p>  <p>81700300 LE</p>	<p>CARCAÇA DE ARTICULAÇÃO</p>  <p>81880300 LE</p>
<p>CARCAÇA DE ARTICULAÇÃO</p>  <p>81880500 LD</p>	<p>CARCAÇA DE ARTICULAÇÃO</p>  <p>82775500 LE</p>	<p>CARCAÇA DE ARTICULAÇÃO</p>  <p>82775600 LD</p>	<p>PORTADOR PLANETÁRIO</p>  <p>80297300</p>
<p>PORTADOR PLANETÁRIO</p>  <p>80607400</p>	<p>PORTADOR PLANETÁRIO</p>  <p>80772900</p>	<p>PORTADOR PLANETÁRIO</p>  <p>80909000</p>	<p>PORTADOR PLANETÁRIO</p>  <p>81703800</p>
<p>PORTADOR PLANETÁRIO</p>  <p>81882400</p>	<p>CUBO</p>  <p>80985700</p>	<p>CUBO</p>  <p>80985720</p>	<p>CUBO</p>  <p>82776400</p>

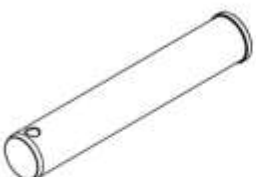
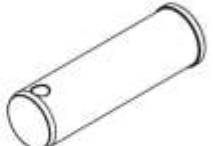
<p>PORCA</p>  <p>80297700</p>	<p>PORCA</p>  <p>80604000</p>	<p>PORCA</p>  <p>80907700</p>	<p>PORCA</p>  <p>81333400</p>
<p>ARRUELA</p>  <p>224262</p>	<p>ARRUELA</p>  <p>246530</p>	<p>ARRUELA</p>  <p>34057900</p>	<p>ARRUELA</p>  <p>34058000</p>
<p>ARRUELA</p>  <p>81711200</p>	<p>ANEL</p>  <p>845890</p>	<p>ANEL</p>  <p>868390</p>	<p>ANEL</p>  <p>31337600</p>
<p>HASTE</p>  <p>615170</p>	<p>HASTE</p>  <p>VALMET P VALMET M VALMET G VALMET E</p>	<p>TAMPA DO MANCAL</p>  <p>440590</p>	<p>ENGRENAGEM</p>  <p>34057000</p>

<p>PINO</p>  <p>14543195</p>	<p>PINO</p>  <p>14616327</p>	<p>PORTADOR PLANETÁRIO</p>  <p>VOE11709369</p>	<p>ENGRENAGEM</p>  <p>11988585</p>
<p>ENGRENAGEM</p>  <p>11988629</p>	<p>GRUPOS PARA ESTEIRA</p>  <p>GR EC210 59 GR EC240</p>		

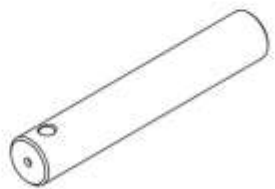
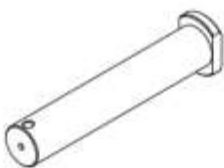
<p>BUCHA</p>  <p>9301645</p>	<p>BUCHA</p>  <p>9301646</p>	<p>BUCHA</p>  <p>9301647</p>	<p>BUCHA</p>  <p>9327923</p>
<p>BUCHA</p>  <p>9328092</p>	<p>BUCHA</p>  <p>011010372</p>	<p>BUCHA</p>  <p>011010373</p>	<p>BUCHA</p>  <p>011010376</p>
<p>BUCHA</p>  <p>13060002</p>	<p>BUCHA</p>  <p>250100180</p>	<p>BUCHA</p>  <p>250100245</p>	<p>BUCHA</p>  <p>252600343</p>
<p>BUCHA</p>  <p>252600350</p>	<p>BUCHA</p>  <p>252600351</p>	<p>BUCHA</p>  <p>252600353</p>	<p>BUCHA</p>  <p>252600572</p>
<p>BUCHA</p>  <p>252600717</p>	<p>BUCHA</p>  <p>402200829</p>	<p>PINO</p>  <p>011010320</p>	<p>PINO</p>  <p>011010364</p>

<p>PINO</p>  <p>011010365</p>	<p>PINO</p>  <p>011010366</p>	<p>PINO</p>  <p>011010367</p>	<p>PINO</p>  <p>011010369</p>
<p>PINO</p>  <p>011010370</p>	<p>PINO</p>  <p>252600335</p>	<p>PINO</p>  <p>252609140</p>	<p>PINO</p>  <p>402201848</p>
<p>PINO</p>  <p>819908998</p>	<p>PINO</p>  <p>300K052</p>		

CONJUNTO CUBO DA RODA PARA MÁQUINA XGMA

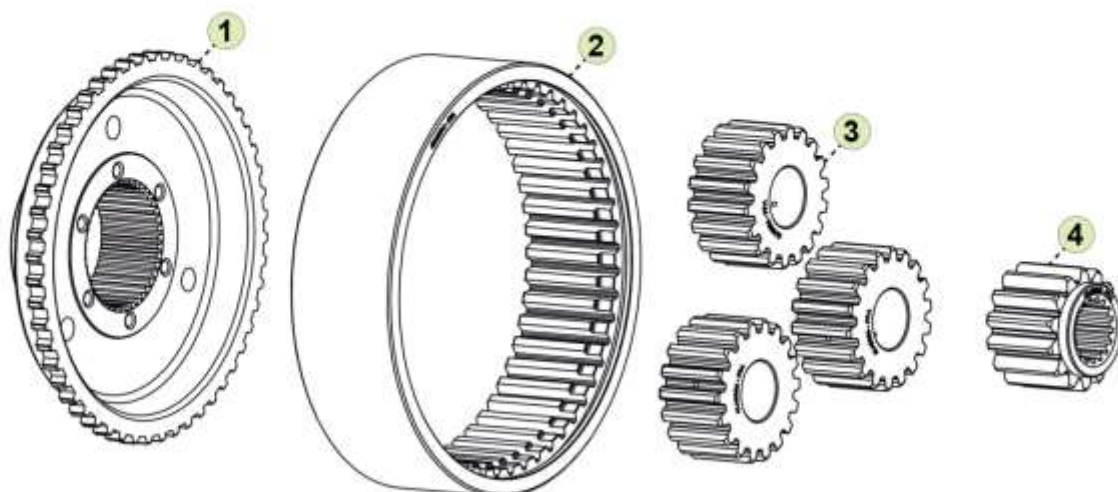

CUBO

42A0007

ENGRENAGEM ANELAR

42A0014

ENGRENAGEM PLANETÁRIA

41A0056

ENGRENAGEM

41A0055





ACOMPANHA

POS.	QTD.	DESCRIÇÃO
1	01	Cubo
2	01	Engrenagem Anelar
3	03	Engrenagem Planetária
4	01	Engrenagem

ENGRENAGEM ANELAR

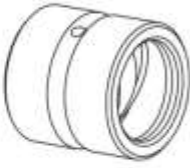

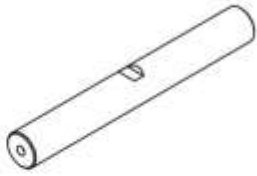
42A0014

<p>BUCHA</p>  <p>163448</p>	<p>BUCHA</p>  <p>666170</p>	<p>PINO</p>  <p>444931</p>	<p>PINO</p>  <p>666168</p>
<p>PINO</p>  <p>666169</p>			

CONJUNTO CARÇA DE ARTICULAÇÃO PARA MÁQUINAS ZF

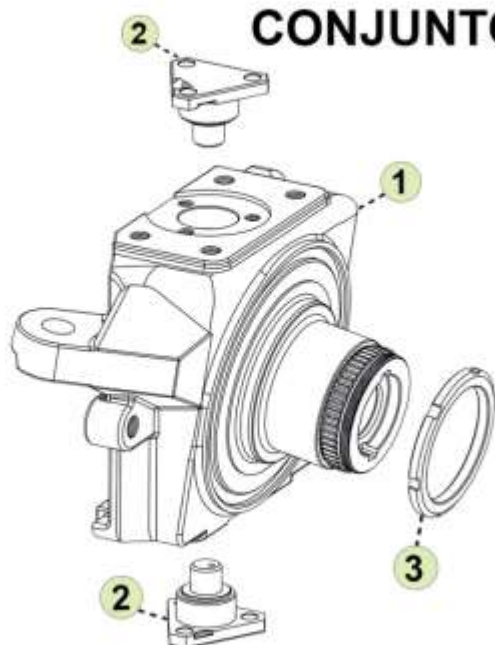











CARÇA DE ARTICULAÇÃO	PIVÔ
0095353245 LE	4472353195
0095353244 LD	4472352162

CARÇA DE ARTICULAÇÃO	PORCA
0095366093 LE	0737503042
0095366095 LD	

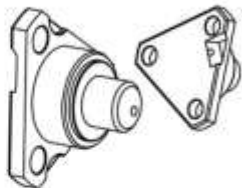
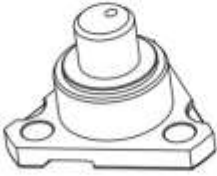
ACOMPANHA

POS.	QTD.	DESCRIÇÃO
1	01	Carça
2	02	Pivô
3	01	Porca

<p>BUCHA</p>  <p>0095353205</p>	<p>BUCHA</p>  <p>0095353348</p>	<p>BUCHA</p>  <p>0095308002</p>	<p>BUCHA</p>  <p>0095308006</p>
<p>BUCHA</p>  <p>0095355044</p>	<p>BUCHA</p>  <p>4472353516</p>	<p>BUCHA</p>  <p>4472353544</p>	<p>PIVÔ (FORJADO)</p>  <p>4472352162 (Antigo)</p>
<p>PIVÔ (FORJADO)</p>  <p>4472353195</p>	<p>EIXO</p>  <p>0095366153</p>	<p>EIXO</p>  <p>0095366171</p>	<p>EIXO</p>  <p>0095366172</p>

<p>CARCAÇA DE ARTICULAÇÃO</p> <p>0095353244 LD</p>	<p>CARCAÇA DE ARTICULAÇÃO</p> <p>0095353245 LE</p>	<p>CARCAÇA DE ARTICULAÇÃO</p> <p>0095366093 LE</p>	<p>CARCAÇA DE ARTICULAÇÃO</p> <p>0095366095 LD</p>
<p>PORTADOR PLANETÁRIO</p> <p>0095353276</p>	<p>PORTADOR PLANETÁRIO</p> <p>0095366092</p>	<p>PORTADOR PLANETÁRIO</p> <p>0095366097</p>	<p>PORTADOR PLANETÁRIO</p> <p>4472355086</p>
<p>PORTADOR PLANETÁRIO</p> <p>4472352103</p>	<p>PORTADOR PLANETÁRIO</p> <p>4472353077</p>	<p>PORTADOR PLANETÁRIO</p> <p>4472353183</p>	<p>ARRUELA</p> <p>0095308001</p>
<p>ARRUELA</p> <p>4472366045</p>	<p>PORCA</p> <p>0737503041</p>	<p>PORCA</p> <p>0737503042</p>	

GRUPOS E EIXOS PARA ESTEIRA



TRANSBORDO

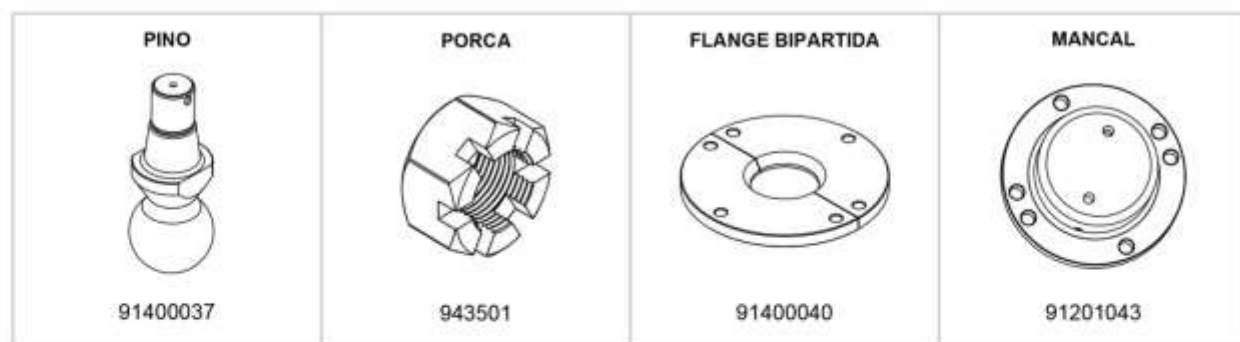



Através de constantes investimentos em tecnologia e processos, a equipe Black atua tendo como fundamento a excelência na qualidade dos produtos e ótima relação cliente/empresa, cuja satisfação é prioridade.

PEÇAS AGRÍCOLAS

Qualidade e Durabilidade

B **Black**
R O D O A G R O